



Intermediate drive unit

- miniDrive WS 10m V+A**
- miniDrive WS 15m V+A**
- miniDrive WS 20m V+A**
- miniDrive WS 25m V+A**

099-005396-EW501

Observe additional system documents!

04.04.2016

**Register now  
and benefit!**  
**Jetzt Registrieren  
und Profitieren!**

[www.ewm-group.com](http://www.ewm-group.com)



# General instructions

## CAUTION



### **Read the operating instructions!**

**The operating instructions provide an introduction to the safe use of the products.**

- Read the operating instructions for all system components!
- Observe accident prevention regulations!
- Observe all local regulations!
- Confirm with a signature where appropriate.



***In the event of queries on installation, commissioning, operation or special conditions at the installation site, or on usage, please contact your sales partner or our customer service department on +49 2680 181-0.***

***A list of authorised sales partners can be found at [www.ewm-group.com](http://www.ewm-group.com).***

Liability relating to the operation of this equipment is restricted solely to the function of the equipment. No other form of liability, regardless of type, shall be accepted. This exclusion of liability shall be deemed accepted by the user on commissioning the equipment.

The manufacturer is unable to monitor whether or not these instructions or the conditions and methods are observed during installation, operation, usage and maintenance of the equipment. An incorrectly performed installation can result in material damage and injure persons as a result. For this reason, we do not accept any responsibility or liability for losses, damages or costs arising from incorrect installation, improper operation or incorrect usage and maintenance or any actions connected to this in any way.

© EWM AG · Dr. Günter-Henle-Str. 8 · D-56271 Mündersbach, Germany

The copyright to this document remains the property of the manufacturer.

Reprinting, including extracts, only permitted with written approval.

The content of this document has been prepared and reviewed with all reasonable care. The information provided is subject to change, errors excepted.

# 1 Contents

<b>1</b>	<b>Contents</b>	<b>3</b>
<b>2</b>	<b>Safety instructions</b>	<b>5</b>
2.1	Notes on the use of these operating instructions	5
2.2	Explanation of icons	6
2.3	General	7
2.4	Transport and installation	11
2.4.1	Ambient conditions	12
2.4.1.1	In operation	12
2.4.1.2	Transport and storage	12
<b>3</b>	<b>Intended use</b>	<b>13</b>
3.1	Use and operation solely with the following machines	13
3.2	Documents which also apply	14
3.2.1	Warranty	14
3.2.2	Declaration of Conformity	14
3.2.3	Welding in environments with increased electrical hazards	14
3.2.4	Service documents (spare parts and circuit diagrams)	14
3.2.5	Calibration/Validation	14
<b>4</b>	<b>Machine description – quick overview</b>	<b>15</b>
4.1	Front view	15
4.2	Inside view	16
<b>5</b>	<b>Design and function</b>	<b>17</b>
5.1	General	17
5.2	Transport and installation	18
5.3	Preparing the welding system	18
5.3.1	Switching between Push/Pull and intermediate drive	18
5.4	Welding torch cooling system	20
5.4.1	List of coolants	20
5.4.2	Maximal hose package length	20
5.5	Welding torch connection	21
5.6	Hose package/intermediate drive connection	23
5.7	Wire feed	23
5.7.1	Open the protective flap of the wire feeder	23
5.7.2	Changing the wire feed rollers	23
5.7.3	Inching the wire electrode	24
5.8	Welding data display	26
5.8.1	Setting the operating point (welding output)	26
5.9	Replacing the steel liner in the hose package	27
<b>6</b>	<b>Maintenance, care and disposal</b>	<b>29</b>
6.1	General	29
6.2	Maintenance work, intervals	29
6.2.1	Daily maintenance tasks	29
6.2.1.1	Visual inspection	29
6.2.1.2	Functional test	29
6.2.2	Monthly maintenance tasks	30
6.2.2.1	Visual inspection	30
6.2.2.2	Functional test	30
6.2.3	Annual test (inspection and testing during operation)	30
6.3	Disposing of equipment	30
6.3.1	Manufacturer's declaration to the end user	30
6.4	Meeting the requirements of RoHS	30
<b>7</b>	<b>Rectifying faults</b>	<b>31</b>
7.1	Checklist for rectifying faults	31
7.2	Vent coolant circuit	32
<b>8</b>	<b>Technical data</b>	<b>33</b>
8.1	miniDrive	33

<b>9 Accessories .....</b>	<b>34</b>
9.1 Remote control / connection cable.....	34
9.2 General accessories .....	34
<b>10 Replaceable parts.....</b>	<b>35</b>
10.1 Conversion kit .....	35
10.2 Wire feed rollers .....	35
10.2.1 Wire feed rollers for steel wire .....	35
10.2.2 Wire feed rollers for aluminium wire .....	35
10.2.3 Wire feed rollers for cored wire.....	35
<b>11 Appendix A.....</b>	<b>37</b>
11.1 Circuit diagram – cable adapter .....	37
<b>12 Appendix B.....</b>	<b>38</b>
12.1 Overview of EWM branches.....	38

## 2 Safety instructions

### 2.1 Notes on the use of these operating instructions

#### **DANGER**

**Working or operating procedures which must be closely observed to prevent imminent serious and even fatal injuries.**

- Safety notes include the "DANGER" keyword in the heading with a general warning symbol.
- The hazard is also highlighted using a symbol on the edge of the page.

#### **WARNING**

**Working or operating procedures which must be closely observed to prevent serious and even fatal injuries.**

- Safety notes include the "WARNING" keyword in the heading with a general warning symbol.
- The hazard is also highlighted using a symbol in the page margin.

#### **CAUTION**

**Working or operating procedures which must be closely observed to prevent possible minor personal injury.**

- The safety information includes the "CAUTION" keyword in its heading with a general warning symbol.
- The risk is explained using a symbol on the edge of the page.

#### **CAUTION**

**Working and operating procedures which must be followed precisely to avoid damaging or destroying the product.**















- The safety information includes the "CAUTION" keyword in its heading without a general warning symbol.
- The hazard is explained using a symbol at the edge of the page.

#### **Special technical points which users must observe.**

Instructions and lists detailing step-by-step actions for given situations can be recognised via bullet points, e.g.:

- Insert the welding current lead socket into the relevant socket and lock.

## 2.2 Explanation of icons

Symbol	Description
	Special technical points which users must observe.
	Correct
	Wrong
	Press
	Do not press
	Press and keep pressed
	Turn
	Switch
	Switch off machine
	Switch on machine
<b>ENTER</b>	enter the menu
<b>NAVIGATION</b>	Navigating in the menu
<b>EXIT</b>	Exit the menu
4 s 	Time display (example: wait 4s/press)
	Interruption in the menu display (other setting options possible)
	Tool not required/do not use
	Tool required/use

## 2.3 General

### **DANGER**



#### **Electromagnetic fields!**

The power source may cause electrical or electromagnetic fields to be produced which could affect the correct functioning of electronic equipment such as IT or CNC devices, telecommunication lines, power cables, signal lines and pacemakers.

- Observe the maintenance instructions > see 6 chapter!
- Unwind welding leads completely!
- Shield devices or equipment sensitive to radiation accordingly!
- The correct functioning of pacemakers may be affected (obtain advice from a doctor if necessary).



#### **Do not carry out any unauthorised repairs or modifications!**

To avoid injury and equipment damage, the unit must only be repaired or modified by specialist, skilled persons!

The warranty becomes null and void in the event of unauthorised interference.

- Appoint only skilled persons for repair work (trained service personnel)!



#### **Electric shock!**

Welding machines use high voltages which can result in potentially fatal electric shocks and burns on contact. Even low voltages can cause you to get a shock and lead to accidents.

- Do not touch any live parts in or on the machine!
- Connection cables and leads must be free of faults!
- Switching off alone is not sufficient!
- Place welding torch and stick electrode holder on an insulated surface!
- The unit should only be opened by specialist staff after the mains plug has been unplugged!
- Only wear dry protective clothing!
- Wait for 4 minutes until the capacitors have discharged!

### **WARNING**



#### **Validity of the document!**

This document is valid only in combination with the operating instructions for the product being used!

- Read and observe the operating instructions for all system components, especially the safety instructions!



#### **Risk of accidents due to non-compliance with the safety instructions!**

**Non-compliance with the safety instructions can be fatal!**

- Carefully read the safety instructions in this manual!
- Observe the accident prevention regulations and any regional regulations!
- Inform persons in the working area that they must comply with the regulations!



#### **Explosion risk!**

Apparently harmless substances in closed containers may generate excessive pressure when heated.

- Move containers with inflammable or explosive liquids away from the working area!
- Never heat explosive liquids, dusts or gases by welding or cutting!

## WARNING



### **Risk of injury due to radiation or heat!**

**Arc radiation results in injury to skin and eyes.**

**Contact with hot workpieces and sparks results in burns.**

- Use welding shield or welding helmet with the appropriate safety level (depending on the application)!
- Wear dry protective clothing (e.g. welding shield, gloves, etc.) according to the relevant regulations in the country in question!
- Protect persons not involved in the work against arc beams and the risk of glare using safety curtains!



### **Smoke and gases!**

**Smoke and gases can lead to breathing difficulties and poisoning. In addition, solvent vapour (chlorinated hydrocarbon) may be converted into poisonous phosgene due to the ultraviolet radiation of the arc!**

- Ensure that there is sufficient fresh air!
- Keep solvent vapour away from the arc beam field!
- Wear suitable breathing apparatus if appropriate!



### **Fire hazard!**

**Flames may arise as a result of the high temperatures, stray sparks, glowing-hot parts and hot slag produced during the welding process.**

**Stray welding currents can also result in flames forming!**

- Check for fire hazards in the working area!
- Do not carry any easily flammable objects such as matches or lighters.
- Keep appropriate fire extinguishing equipment to hand in the working area!
- Thoroughly remove any residue of flammable substances from the workpiece before starting welding.
- Only continue work on welded workpieces once they have cooled down.  
Do not allow to come into contact with flammable material!
- Connect welding leads correctly!



### **Danger when coupling multiple power sources!**

**Coupling multiple power sources in parallel or in series has to be carried out by qualified personnel and in accordance with the manufacturer's guidelines. Before bringing the power sources into service for arc welding operations, a test has to verify that they cannot exceed the maximum allowed open circuit voltage.**

- Connection of the machine may be carried out by qualified personnel only!
- When decommissioning individual power sources, all mains and welding current leads have to be safely disconnected from the welding system as a whole. (Danger due to inverse voltages!)
- Do not couple welding machines with pole reversing switch (PWS series) or machines for AC welding, as a minor error in operation can cause the welding voltages to be combined.

## CAUTION



### **Noise exposure!**

**Noise exceeding 70 dBA can cause permanent hearing damage!**

- Wear suitable ear protection!
- Persons located within the working area must wear suitable ear protection!



## CAUTION

**Obligations of the operator!****The respective national directives and laws must be observed for operation of the machine!**

- National implementation of the framework directive (89/391/EWG), as well as the associated individual directives.
- In particular, directive (89/655/EWG), on the minimum regulations for safety and health protection when staff members use equipment during work.
- The regulations regarding work safety and accident prevention for the respective country.
- Setting up and operating the machine according to IEC 60974-9.
- Check at regular intervals that users are working in a safety-conscious way.
- Regular checks of the machine according to IEC 60974-4.

**Damage due to the use of non-genuine parts!****The manufacturer's warranty becomes void if non-genuine parts are used!**

- Only use system components and options (power sources, welding torches, electrode holders, remote controls, spare parts and replacement parts, etc.) from our range of products!
- Only insert and lock accessory components into the relevant connection socket when the machine is switched off.

**Damage to the machine due to stray welding currents!****Stray welding currents can destroy protective earth conductors, damage equipment and electronic devices and cause overheating of components leading to fire.**

- Make sure all welding leads are securely connected and check regularly.
- Always ensure a proper and secure electrical connection to the workpiece!
- Set up, attach or suspend all conductive power source components like casing, transport vehicle and crane frames so they are insulated!
- Do not place any other electronic devices such as drillers or angle grinders, etc., on the power source, transport vehicle or crane frames unless they are insulated!
- Always put welding torches and electrode holders on an insulated surface when they are not in use!

**Mains connection****Requirements for connection to the public mains network**

High-performance machines can influence the mains quality by taking current from the mains network. For some types of machines, connection restrictions or requirements relating to the maximum possible line impedance or the necessary minimum supply capacity at the interface with the public network (Point of Common Coupling, PCC) can therefore apply. In this respect, attention is also drawn to the machines' technical data. In this case, it is the responsibility of the operator, where necessary in consultation with the mains network operator, to ensure that the machine can be connected.

## CAUTION



### EMC Machine Classification

In accordance with IEC 60974-10, welding machines are grouped in two electromagnetic compatibility classes > see 8 chapter:

**Class A** machines are not intended for use in residential areas where the power supply comes from the low-voltage public mains network. When ensuring the electromagnetic compatibility of class A machines, difficulties can arise in these areas due to interference not only in the supply lines but also in the form of radiated interference.

**Class B** machines fulfil the EMC requirements in industrial as well as residential areas, including residential areas connected to the low-voltage public mains network.

### Setting up and operating

When operating arc welding systems, in some cases, electro-magnetic interference can occur although all of the welding machines comply with the emission limits specified in the standard. The user is responsible for any interference caused by welding.

In order to **evaluate** any possible problems with electromagnetic compatibility in the surrounding area, the user must consider the following: (see also EN 60974-10 Appendix A)

- Mains, control, signal and telecommunication lines
- Radios and televisions
- Computers and other control systems
- Safety equipment
- The health of neighbouring persons, especially if they have a pacemaker or wear a hearing aid
- Calibration and measuring equipment
- The immunity to interference of other equipment in the surrounding area
- The time of day at which the welding work must be carried out

### Recommendations for **reducing interference emission**

- Mains connection, e.g. additional mains filter or shielding with a metal tube
- Maintenance of the arc welding equipment
- Welding leads should be as short as possible and run closely together along the ground
- Potential equalization
- Earthing of the workpiece. In cases where it is not possible to earth the workpiece directly, it should be connected by means of suitable capacitors.
- Shielding from other equipment in the surrounding area or the entire welding system

## 2.4 Transport and installation

### WARNING



#### **Incorrect handling of shielding gas cylinders!**

**Incorrect handling of shielding gas cylinders can result in serious and even fatal injury.**

- Observe the instructions from the gas manufacturer and in any relevant regulations concerning the use of compressed air!
- Place shielding gas cylinders in the holders provided for them and secure with fixing devices.
- Avoid heating the shielding gas cylinder!



#### **Risk of accident due to improper transport of machines that may not be lifted!**

**Do not lift or suspend the machine! The machine can fall down and cause injuries! The handles and brackets are suitable for transport by hand only!**

- The machine may not be lifted by crane or suspended!

### CAUTION



#### **Damage due to supply lines not being disconnected!**

**During transport, supply lines which have not been disconnected (mains supply leads, control leads, etc.) may cause hazards such as connected equipment tipping over and injuring persons!**

- Disconnect supply lines!

## 2.4.1 Ambient conditions

### CAUTION



#### Installation site!

**The machine must not be operated in the open air and must only be set up and operated on a suitable, stable and level base!**

- The operator must ensure that the ground is non-slip and level, and provide sufficient lighting for the place of work.
- Safe operation of the machine must be guaranteed at all times.

### CAUTION



#### Equipment damage due to dirt accumulation!

**Unusually high quantities of dust, acid, corrosive gases or substances may damage the equipment.**

- Avoid high volumes of smoke, vapour, oil vapour and grinding dust!
- Avoid ambient air containing salt (sea air)!



#### Non-permissible ambient conditions!

**Insufficient ventilation results in a reduction in performance and equipment damage.**

- Observe the ambient conditions!
- Keep the cooling air inlet and outlet clear!
- Observe the minimum distance of 0.5 m from obstacles!

### 2.4.1.1 In operation

#### Temperature range of the ambient air:

- -25 °C to +40 °C

#### Relative air humidity:

- Up to 50% at 40 °C
- Up to 90% at 20 °C

### 2.4.1.2 Transport and storage

#### Storage in an enclosed space, temperature range of the ambient air:

- -30 °C to +70 °C

#### Relative air humidity

- Up to 90% at 20 °C

### 3 Intended use

#### WARNING



##### **Hazards due to improper usage!**

**Hazards may arise for persons, animals and material objects if the equipment is not used correctly. No liability is accepted for any damages arising from improper usage!**

- The equipment must only be used in line with proper usage and by trained or expert staff!
- Do not modify or convert the equipment improperly!

Wire feeder (intermediate drive) for welding wire electrodes used for gas-shielded metal-arc welding and hose packages of up to 25 m.

#### 3.1 Use and operation solely with the following machines



***A compact or decompact system component with wire feeder is required to operate the intermediate drive.***



***In addition, the system component has to be equipped with a current M 3.7x-A variant machine control (three digital displays).***

The following machine series can be combined with the intermediate drive:

- Taurus Synergic S
- Phoenix
- alpha Q

All compact 355 TKM and 355 TKW machines in the relevant series are excluded.

## 3.2 Documents which also apply

### 3.2.1 Warranty

 For more information refer to the "Warranty registration" brochure supplied and our information regarding warranty, maintenance and testing at [www.ewm-group.com](http://www.ewm-group.com)!

### 3.2.2 Declaration of Conformity

 The designated machine conforms to EC Directives and standards in terms of its design and construction:

- EC Low Voltage Directive (2006/95/EC),
- EC EMC Directive (2004/108/EC),

This declaration shall become null and void in the event of unauthorised modifications, improperly conducted repairs, non-observance of the deadlines for the repetition test and / or non-permitted conversion work not specifically authorised by the manufacturer.

The original copy of the declaration of conformity is enclosed with the unit.

### 3.2.3 Welding in environments with increased electrical hazards

 In compliance with IEC / DIN EN 60974, VDE 0544 the machines can be used in environments with an increased electrical hazard.

### 3.2.4 Service documents (spare parts and circuit diagrams)

 **DANGER**



**Do not carry out any unauthorised repairs or modifications!**  
**To avoid injury and equipment damage, the unit must only be repaired or modified by specialist, skilled persons!**  
**The warranty becomes null and void in the event of unauthorised interference.**

- Appoint only skilled persons for repair work (trained service personnel)!

Original copies of the circuit diagrams are enclosed with the unit.

Spare parts can be obtained from the relevant authorised dealer.

### 3.2.5 Calibration/Validation

We hereby confirm that this machine has been tested using calibrated measuring equipment, as stipulated in IEC/EN 60974, ISO/EN 17662, EN 50504, and complies with the admissible tolerances.

Recommended calibration interval: 12 months







## 4 Machine description – quick overview

### 4.1 Front view

 Connections and operating elements for torch cooling only with correspondent machine versions.

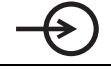

Figure 4-1

Item	Symbol	Description
1		<b>Carrying handle</b>
2		<b>Wire speed rotary dial</b> Infinitely adjustable setting of the wire speed from min. to max. (welding output, one-dial operation)
3		<b>Display, left &gt; see 5.8 chapter</b> AMP -----welding current ⊗ wire feed speed
4		<b>Welding torch connection (Euro torch connector)</b> Welding current, shielding gas and torch trigger integrated
5		<b>Quick connect coupling (red)</b> coolant return
6		<b>Quick connect coupling (blue)</b> coolant supply
7		<b>19-pole connection socket (analogue)</b> For connecting analogue accessory components (remote control, welding torch control lead, etc.)
8		<b>Display, right &gt; see 5.8 chapter</b> V welding voltage
9		<b>Rotary dial, Arc length correction</b> Arc length correction from -10 V to + 10 V

## 4.2 Inside view

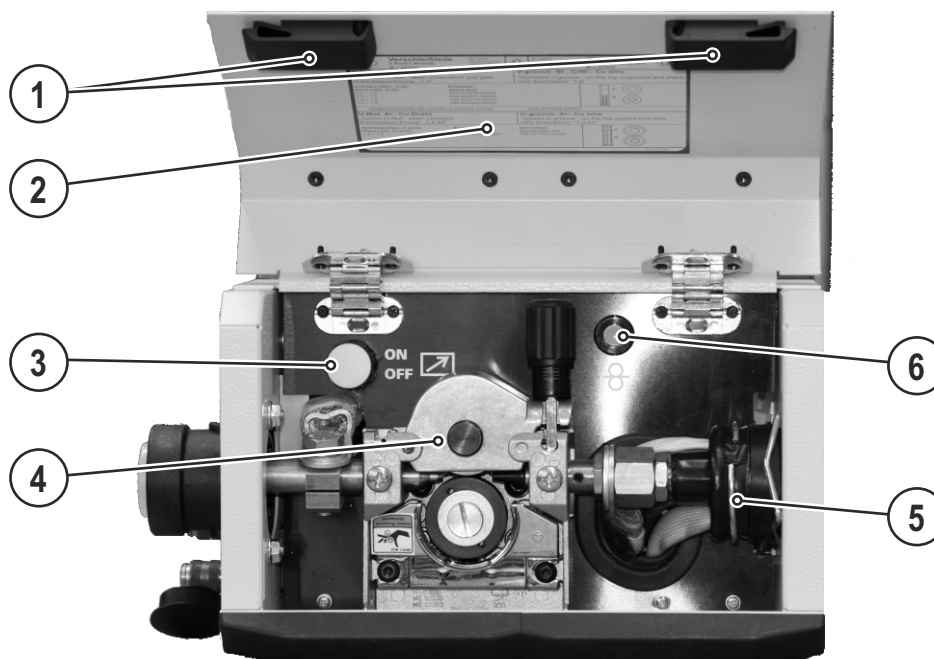

Figure 4-2

Item	Symbol	Description
1		<b>Slide latch, lock for the protective cap</b>
2		<b>Protective cap</b> Cover for the wire feed mechanism and other operating elements. Depending on the machine series, additional stickers with information on the replacement parts and JOB lists will be located on the inside.
3		<b>Changeover switch, remote control on/off</b> ON     Set the welding performance via the remote control OFF    Set the welding performance via the machine control
4		<b>Wire feed unit</b>
5		<b>Intermediate hose package</b>
6		<b>Button, Wire inching</b> For inching the wire electrode when changing the wire spool. The welding wire is inched into the tube package with the current off and without the gas being expelled.



**The inching speed is infinitely adjustable by simultaneously pressing the wire inching push-button and turning the wire speed rotary knob.**



## 5 Design and function

### 5.1 General

#### WARNING



##### **Risk of injury from electric shock!**

**Contact with live parts, e.g. welding current sockets, is potentially fatal!**

- Follow safety instructions on the opening pages of the operating instructions.
- Commissioning may only be carried out by persons who have the relevant expertise of working with arc welding machines!
- Connection and welding leads (e.g. electrode holder, welding torch, workpiece lead, interfaces) may only be connected when the machine is switched off!

#### CAUTION



##### **Insulate the arc welder from welding voltage!**

**Not all active parts of the welding current circuit can be shielded from direct contact. To avoid any associated risks it is vital for the welder to adhere to the relevant safety regulations. Even low voltages can cause a shock and lead to accidents.**

- Wear dry and undamaged protective clothing (shoes with rubber soles/welder's gloves made from leather without any studs or braces)!
- Avoid direct contact with non-insulated connection sockets or connectors!
- Always place torches and electrode holders on an insulated surface!



##### **Risk of burns on the welding current connection!**

**If the welding current connections are not locked, connections and leads heat up and can cause burns, if touched!**

- Check the welding current connections every day and lock by turning in clockwise direction, if necessary.



##### **Risk of injury due to moving parts!**

**The wire feeders are equipped with moving parts, which can trap hands, hair, clothing or tools and thus injure persons!**

- Do not reach into rotating or moving parts or drive components!
- Keep casing covers or protective caps closed during operation!



##### **Risk of injury due to welding wire escaping in an unpredictable manner!**

**Welding wire can be conveyed at very high speeds and, if conveyed incorrectly, may escape in an uncontrolled manner and injure persons!**

- Before mains connection, set up the complete wire guide system from the wire spool to the welding torch!
- Remove the pressure rollers from the wire feeder if no welding torch is fitted!
- Check wire guide at regular intervals!
- Keep all casing covers or protective caps closed during operation!



##### **Risk from electrical current!**

**If welding is carried out alternately using different methods and if a welding torch and an electrode holder remain connected to the machine, the open-circuit/welding voltage is applied simultaneously on all cables.**

- The torch and the electrode holder should therefore always be placed on an insulated surface before starting work and during breaks.

## CAUTION



### Damage due to incorrect connection!

**Accessory components and the power source itself can be damaged by incorrect connection!**

- Only insert and lock accessory components into the relevant connection socket when the machine is switched off.
- Comprehensive descriptions can be found in the operating instructions for the relevant accessory components.
- Accessory components are detected automatically after the power source is switched on.



### Using protective dust caps!

**Protective dust caps protect the connection sockets and therefore the machine against dirt and damage.**

- The protective dust cap must be fitted if there is no accessory component being operated on that connection.
- The cap must be replaced if faulty or if lost!



*Observe documentation of other system components when connecting!*

## 5.2 Transport and installation



## WARNING



**Risk of accident due to improper transport of machines that may not be lifted!**

**Do not lift or suspend the machine! The machine can fall down and cause injuries! The handles and brackets are suitable for transport by hand only!**

- The machine may not be lifted by crane or suspended!



## CAUTION



**Installation site!**

**The machine must not be operated in the open air and must only be set up and operated on a suitable, stable and level base!**

- The operator must ensure that the ground is non-slip and level, and provide sufficient lighting for the place of work.
- Safe operation of the machine must be guaranteed at all times.

## 5.3 Preparing the welding system

### 5.3.1 Switching between Push/Pull and intermediate drive



## DANGER



**Do not carry out any unauthorised repairs or modifications!**

**To avoid injury and equipment damage, the unit must only be repaired or modified by specialist, skilled persons!**

**The warranty becomes null and void in the event of unauthorised interference.**

- Appoint only skilled persons for repair work (trained service personnel)!

The wire feeder used in the welding system has to be modified for use with an intermediate drive. To do so, unscrew the casing cover and perform the following two actions on PCB M370/1E:

### Replug the connector (X23/X24)

Plug	Function
On X24	Use with push/pull welding torch (ex factory)
On X23	Use with intermediate drive

### Install cable adapter

The cable adapter (included with the intermediate drive) has to be added to the wire feeder cable harness.

The cable adapter has to be plugged in at three locations (X2, X3 and X5) between the relevant PCB connections and cable plugs (see attached circuit diagram > see 11.1 chapter):

- PCB M370/1E, connection X2 (18-pole)
- PCB M370/1E, connection X3 (2-pole)
- PCB M370/1E, connection X5 (12-pole)

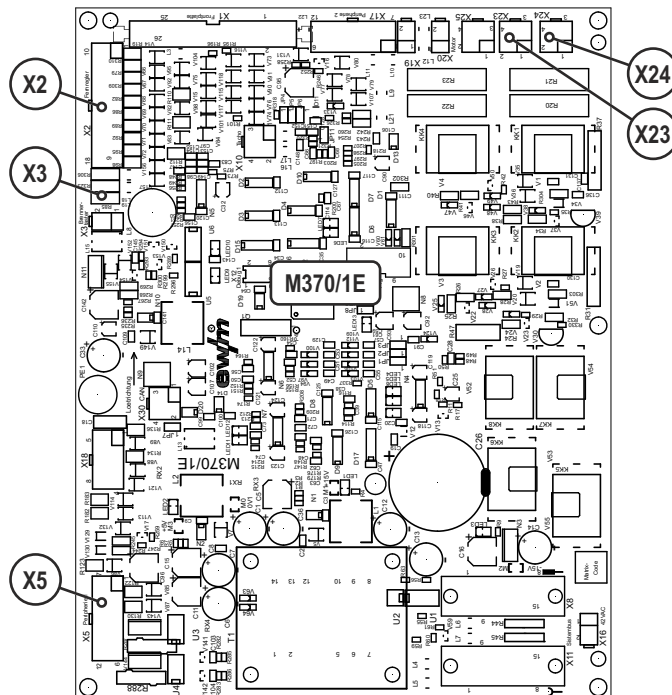

Figure 5-1

## CAUTION



### Test!

Before re-commissioning, it is essential that an "inspection and test during operation" is carried out conforming to IEC / DIN EN 60974-4 "Arc welding devices - inspection and testing during operation"!

- For detailed instructions, please see the standard operating instructions for the welding machine.

## 5.4 Welding torch cooling system

### CAUTION



#### Coolant mixtures!

Mixtures with other liquids or the use of unsuitable coolants result in material damage and renders the manufacturer's warranty void!

- Only use the coolant described in this manual (overview of coolants).
- Do not mix different coolants.
- When changing the coolant, the entire volume of liquid must be changed.



#### Insufficient frost protection in the welding torch coolant!

Depending on the ambient conditions, different liquids are used for cooling the welding torch > see 5.4.1 chapter.

Coolants with frost protection (KF 37E or KF 23E) must be checked regularly to ensure that the frost protection is adequate to prevent damage to the machine or the accessory components.

- The coolant must be checked for adequate frost protection with the TYP 1 frost protection tester .
- Replace coolant as necessary if frost protection is inadequate!



**The disposal of coolant must be carried out according to official regulations and observing the relevant safety data sheets (German waste code number: 70104)!**

**Coolant must not be disposed of together with household waste.**

**Coolant must not be discharged into the sewerage system.**

**Recommended cleaning agent: water, if necessary with cleaning agent added.**

### 5.4.1 List of coolants

The following coolants may be used > see 9 chapter:

Coolant	Temperature range
KF 23E (Standard)	-10 °C to +40 °C
KF 37E	-20 °C to +10 °C

### 5.4.2 Maximal hose package length

	Pump 3.5 bar	Pump 4.5 bar
Machines with or without separate wire feeder	30 m	60 m
Compact machines with additional intermediate drive (example. miniDrive)	20 m	30 m
Machines with separate wire feeder and additional intermediate drive (example: miniDrive)	20 m	60 m

Data as a rule refer to the entire hose package length

including welding torch. The pump output is shown on the type plate (parameter: Pmax).

Pump 3.5 bar: Pmax = 0.35 MPa (3.5 bar)

Pump 4.5 bar: Pmax = 0.45 MPa (4.5 bar)

## 5.5 Welding torch connection

### CAUTION



#### Equipment damage due to improperly connected coolant pipes!

If the coolant pipes are not properly connected or a gas-cooled welding torch is used, the coolant circuit is interrupted and equipment damage can occur.

- Connect all coolant pipes correctly!
- Completely unroll the hose package and the torch hose package!
- Observe maximal hose package length > see 5.4 chapter.
- When using a gas-cooled welding torch, use a hose bridge to establish the coolant circuit > see 9 chapter.



**On delivery, the Euro torch connector is fitted with a capillary tube for welding torches with a steel liner. Conversion is necessary if a welding torch with a liner is used!**

- **Operate welding torches with a liner > with a guide tube.**
- **Operate welding torches with a steel liner > with a capillary tube.**

**Depending on the wire electrode diameter or type, either a steel liner or liner with the correct inner diameter must be inserted in the torch!**

Recommendation:

- Use a steel liner when welding hard, unalloyed wire electrodes (steel).
- Use a chrome nickel liner when welding hard, high-alloy wire electrodes (CrNi).
- Use a liner to weld or braze soft wire electrodes, high-alloy wire electrodes or aluminium materials.

#### **Preparation for connecting welding torches with a liner:**

- Push forward the capillary tube on the wire feed side in the direction of the Euro torch connector and remove it there.
- Insert the liner guide tube from the Euro torch connector side.
- Carefully insert the welding torch connector with as yet too long a liner into the Euro torch connector and secure with a crown nut.
- Cut off the liner with a liner cutter just before the wire feed roller.
- Loosen the welding torch connector and remove.
- Carefully chamfer the cut off end of the liner with a liner sharpener and sharpen.

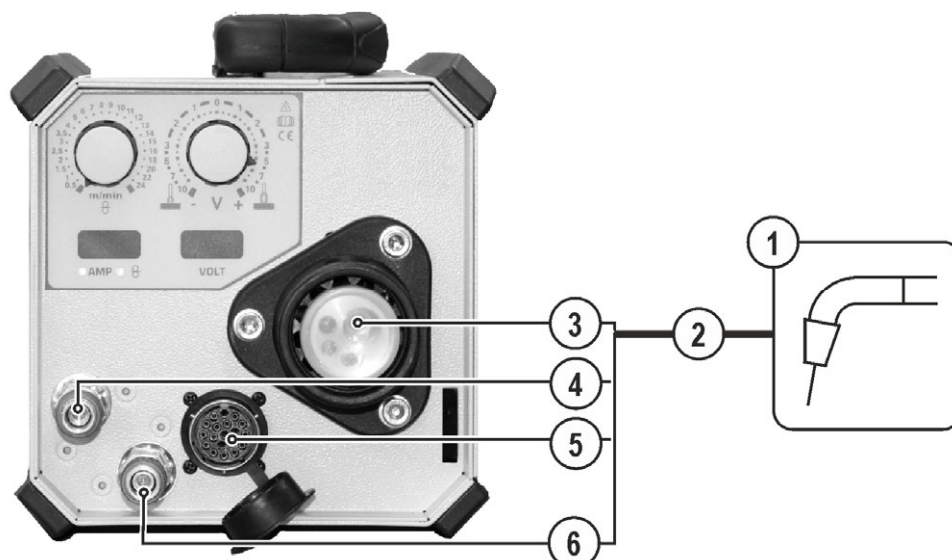

Figure 5-2

Item	Symbol	Description
1		<b>Welding torch</b>
2		<b>Welding torch hose package</b>
3		<b>Welding torch connection (Euro torch connector)</b> Welding current, shielding gas and torch trigger integrated
4		<b>Quick connect coupling (red)</b> coolant return
5		<b>19-pole connection socket (analogue)</b> For connecting analogue accessory components (remote control, welding torch control lead, etc.)
6		<b>Quick connect coupling (blue)</b> coolant supply

- Insert the central plug for the welding torch into the central connector and screw together with crown nut.

**Where applicable:**

- Insert the welding torch control cable into the 19-pole connection socket and lock (MIG/MAG torches with additional control cables only).
- Lock connecting nipples of the cooling water tubes into the corresponding quick connect couplings: Return line red to quick connect coupling, red (coolant return) and supply line blue to quick connect coupling, blue (coolant supply).

## 5.6 Hose package/intermediate drive connection

- Insert central connector of the intermediate hose package into the Euro torch connector of the relevant wire feeder (compact or decompact system component) and secure with crown nut.

 **Observe documentation of other system components when connecting!**

## 5.7 Wire feed

### 5.7.1 Open the protective flap of the wire feeder

#### CAUTION



To perform the following steps, the protective flap of the wire feeder needs to be opened. Make sure to close the protective flap again before starting to work.

- Unlock and open protective flap.

### 5.7.2 Changing the wire feed rollers

 **Unsatisfactory welding results due to faulty wire feeding!**

**Wire feed rollers must be suitable for the diameter of the wire and the material.**

- **Check the roller label to verify that the rollers are suitable for the wire diameter. Turn or change if necessary!**
- **use V-groove rollers with for steel wires and other hard wires.**
- Slide new drive rollers into place so that the diameter of the wire used is visible on the drive roller.
- Screw the drive rollers in place with knurled screws.

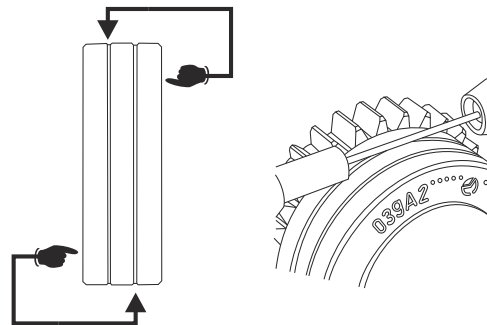

Figure 5-3

## 5.7.3 Inching the wire electrode

### CAUTION



#### **Risk of injury due to moving parts!**

**The wire feeders are equipped with moving parts, which can trap hands, hair, clothing or tools and thus injure persons!**

- Do not reach into rotating or moving parts or drive components!
- Keep casing covers or protective caps closed during operation!



#### **Risk of injury due to welding wire escaping in an unpredictable manner!**

**Welding wire can be conveyed at very high speeds and, if conveyed incorrectly, may escape in an uncontrolled manner and injure persons!**

- Before mains connection, set up the complete wire guide system from the wire spool to the welding torch!
- Remove the pressure rollers from the wire feeder if no welding torch is fitted!
- Check wire guide at regular intervals!
- Keep all casing covers or protective caps closed during operation!



#### **Risk of injury due to welding wire escaping from the welding torch!**

**The welding wire can escape from the welding torch at high speed and cause bodily injury including injuries to the face and eyes!**

- Never direct the welding torch towards your own body or towards other persons!

### CAUTION



#### **Extensive wear due to incorrect contact pressure!**

**Incorrect contact pressure will cause extensive wear of the wire feed rollers!**

- With the adjusting nuts of the pressure units set the contact pressure so that the wire electrode is conveyed but will still slip through if the wire spool jams.
- Set the contact pressure of the front rollers (in wire feed direction) to a higher value!



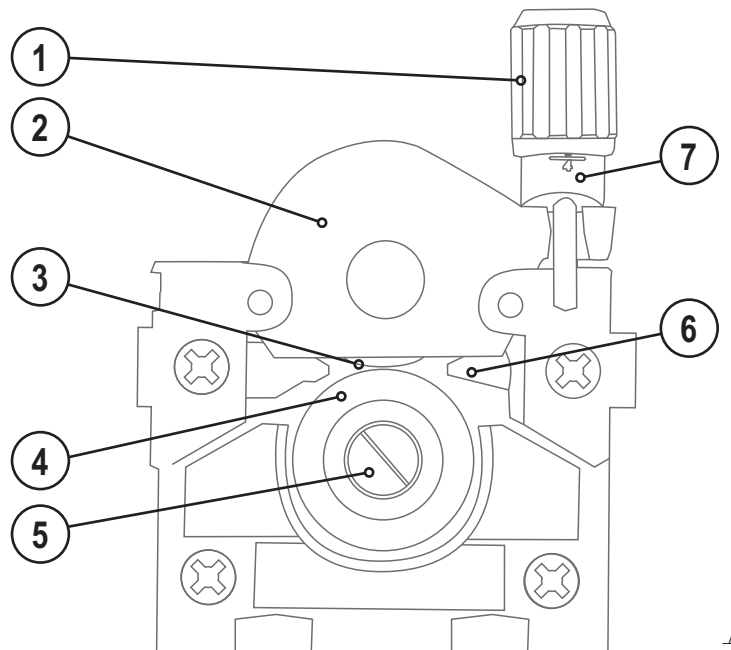

Figure 5-4

Item	Symbol	Description
1		Adjusting nut
2		Clamping unit
3		Pressure roller
4		Drive roller
5		Knurled screw
6		Wire feed nipple
7		Feed roll tensioner Fixing the clamping unit and setting the pressure.

- Extend and lay out the torch hose package.
- Flip feed roll tensioner down towards user (clamping unit will be released)
- Fold tensioning device up
- Schweißdraht vorsichtig vom Drahteinlaufnippel über die Rillen der Antriebsrolle in das Kapillarrohr bzw. Teflonseele mit Drahtführungsrohr einführen.
- Press the tensioning device back down and secure by folding the feed roll tensioner up (wire electrode should be in the groove on the drive roller)
- Set the contact pressure with the adjusting nuts of the feed roll tensioner
- Press the wire inching button until the wire electrode projects out of the welding torch.



**The inching speed is infinitely adjustable by simultaneously pressing the wire inching push-button and turning the wire speed rotary knob. The left display shows the wire feed speed selected, the right display shows the current motor current of the wire feed mechanism.**

## 5.8 Welding data display



Figure 5-5

What is shown on the parameter display depends, among other things, on the selected welding procedure and the machine state (welding, power-saving mode, machine error). Switching the parameters is done at the wire feeder.

Parameter	Nominal values	Actual values	Hold values
Welding current	☑	☑	☑
Wire feed speed	☑	☑	☑
Welding voltage	☑	☑	☑

### 5.8.1 Setting the operating point (welding output)

Operating point setting according to the MIG/MAG single-dial operating principle:

- One of the parameters wire speed, welding current or material thickness is set.
- The control calculates the optimum values for the remaining parameters

The wire speed is generally used to set the operating point.

Operating element	Action	Result
		Operating point setting via wire speed.

The arc length can be corrected as follows.

Operating element	Action	Result
		Arc length correction

## 5.9 Replacing the steel liner in the hose package

 Always make sure the the hose package is straight when replacing the wire guide.

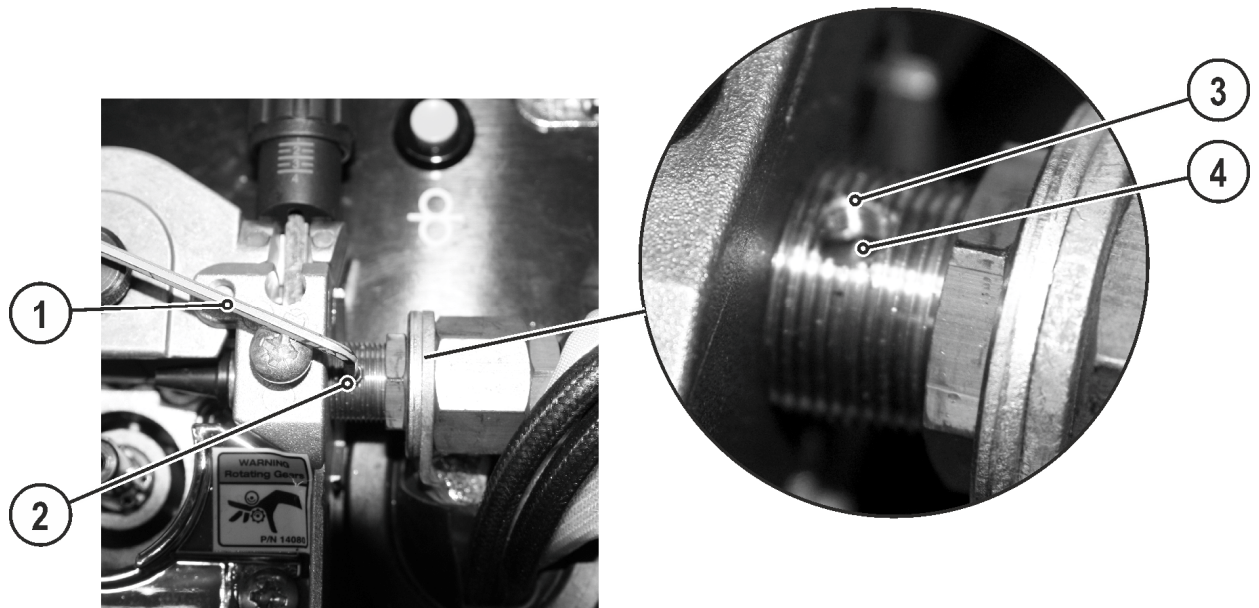

Figure 5-6

Item	Symbol	Description
1		Allen key (size 2.5)
2		Headless screw
3		Threaded hole
4		Steel liner

- Unscrew the headless screw using an Allen key (to release the steel liner from the wire feed mechanism)

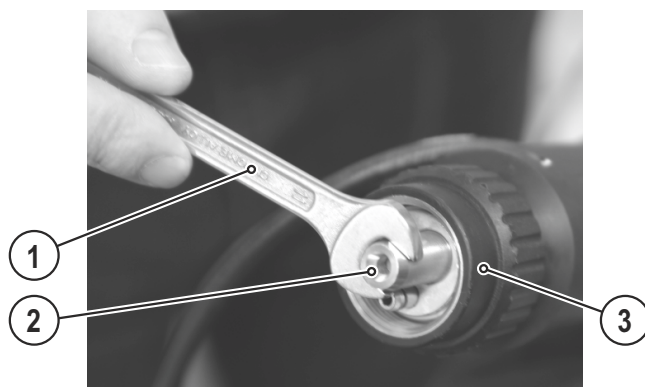

Figure 5-7

Item	Symbol	Description
1		Open-ended spanner, SW 11
2		Crown nut
3		<b>Euro central connection</b> Welding current, shielding gas and torch trigger included

- Loosen the crown nut of the liner fastening
- Pull out steel liner

Due to production tolerances the steel liner length has to be adapted to the hose package used.

- Place new and old steel liner in parallel
- Shorten new steel liner to the total length of the old one
- Insert new steel liner into the Euro torch connector as far as it goes (the steel liner has to be visible inside the headless screw threaded hole)
- Retighten the crown nut of the liner fastening
- Screw headless screw back in using the Allen key (max. torque 2 Nm)

## 6 Maintenance, care and disposal

### **DANGER**



#### **Improper maintenance and testing**

The equipment may only be cleaned, repaired or tested by specialist, skilled persons! A skilled person is one who, due to training, knowledge and experience, is able to recognise the dangers that can occur during testing of this equipment as well as possible subsequent damage and who is able to implement the required safety procedures.

- Complete all tests given in the chapter below!
- Only put the equipment back into operation following a successful test.



#### **Risk of injury from electric shock!**

**Cleaning machines that are not disconnected from the mains can lead to serious injuries!**

- Disconnect the machine completely from the mains.
- Remove the mains plug!
- Wait for 4 minutes until the capacitors have discharged!

Repair and maintenance work may only be performed by qualified authorised personnel; otherwise the right to claim under warranty is void. In all service matters, always consult the dealer who supplied the machine. Return deliveries of defective equipment subject to warranty may only be made through your dealer. When replacing parts, use only original spare parts. When ordering spare parts, please quote the machine type, serial number and item number of the machine, as well as the type designation and item number of the spare part.

### 6.1 General

When used in the specified environmental conditions and under normal operating conditions, this machine is largely maintenance-free and requires a minimum of care.

There are some points, which should be observed, to guarantee fault-free operation of your welding machine. Among these are regular cleaning and checking as described below, depending on the pollution level of the environment and the length of time the unit is in use.

### 6.2 Maintenance work, intervals

#### 6.2.1 Daily maintenance tasks

- Check that all connections and wearing parts are hand-tight and tighten if necessary.
- Check that all screw and plug connections and replaceable parts are secured correctly, tighten if necessary.
- Remove any spatter.
- Clean the wire feed rollers on a regular basis (depending on the degree of soiling).

##### 6.2.1.1 Visual inspection

- Check hose package and power connections for exterior damage and replace or have repaired by specialist staff as necessary!
- Mains supply lead and its strain relief
- Gas tubes and their switching equipment (solenoid valve)
- Other, general condition

##### 6.2.1.2 Functional test

- Check correct mounting of the wire spool.
- Welding current cables (check that they are fitted correctly and secured)
- Gas cylinder securing elements
- Operating, message, safety and adjustment devices (Functional test)

### 6.2.2 Monthly maintenance tasks

#### 6.2.2.1 Visual inspection

- Casing damage (front, rear and side walls)
- Wheels and their securing elements
- Transport elements (strap, lifting lugs, handle)
- Check coolant tubes and their connections for impurities

#### 6.2.2.2 Functional test

- Selector switches, command devices, emergency stop devices, voltage reducing devices, message and control lamps
- Check that the wire guide elements (inlet nipple, wire guide tube) are fitted securely.

### 6.2.3 Annual test (inspection and testing during operation)



***The welding machine may only be tested by competent, capable persons! A capable person is one who, because of his training, knowledge and experience, is able to recognise the dangers that can occur while testing welding power sources as well as possible subsequent damage and who is able to implement the required safety procedures.***



***For more information refer to the "Warranty registration" brochure supplied and our information regarding warranty, maintenance and testing at [www.ewm-group.com](http://www.ewm-group.com)!***

A periodic test according to IEC 60974-4 "Periodic inspection and test" has to be carried out. In addition to the regulations on testing given here, the relevant local laws and regulations must also be observed.

## 6.3 Disposing of equipment



***Proper disposal!***

***The machine contains valuable raw materials, which should be recycled, and electronic components, which must be disposed of.***

- ***Do not dispose of in household waste!***
- ***Observe the local regulations regarding disposal!***



### 6.3.1 Manufacturer's declaration to the end user

- According to European provisions (guideline 2002/96/EG of the European Parliament and the Council of January, 27th 2003), used electric and electronic equipment may no longer be placed in unsorted municipal waste. It must be collected separately. The symbol depicting a waste container on wheels indicates that the equipment must be collected separately. This machine is to be placed for disposal or recycling in the waste separation systems provided for this purpose.
- According to German law (law governing the distribution, taking back and environmentally correct disposal of electric and electronic equipment (ElektroG) from 16.03.2005), used machines are to be placed in a collection system separate from unsorted municipal waste. The public waste management utilities (communities) have created collection points at which used equipment from private households can be disposed of free of charge.
- Information about giving back used equipment or about collections can be obtained from the respective municipal administration office.
- EWM participates in an approved waste disposal and recycling system and is registered in the Used Electrical Equipment Register (EAR) under number WEEE DE 57686922.
- In addition to this, returns are also possible throughout Europe via EWM sales partners.

## 6.4 Meeting the requirements of RoHS

We, EWM AG Mündersbach, hereby confirm that all products supplied by us which are affected by the RoHS Directive, meet the requirements of the RoHS (Directive 2011/65/EU).

## 7 Rectifying faults

All products are subject to rigorous production checks and final checks. If, despite this, something fails to work at any time, please check the product using the following flowchart. If none of the fault rectification procedures described leads to the correct functioning of the product, please inform your authorised dealer.

### 7.1 Checklist for rectifying faults



**The correct machine equipment for the material and process gas in use is a fundamental requirement for perfect operation!**

Legend	Symbol	Description
	↘	Fault/Cause
	✘	Remedy

#### Coolant error/no coolant flowing

- ↘ Insufficient coolant flow
  - ✘ Check coolant level and refill if necessary
- ↘ Air in the coolant circuit
  - ✘ Vent coolant circuit > see 7.2 chapter

#### Wire feed problems

- ↘ Contact tip blocked
  - ✘ Clean, spray with anti-spatter spray and replace if necessary
- ↘ Setting the spool brake
  - ✘ Check settings and correct if necessary
- ↘ Setting pressure units > see 5.7.3 chapter
  - ✘ Check settings and correct if necessary
- ↘ Worn wire rolls
  - ✘ Check and replace if necessary
- ↘ Wire feed motor without supply voltage (automatic cutout triggered by overloading)
  - ✘ Reset triggered fuse (rear of the power source) by pressing the key button
- ↘ Kinked hose packages
  - ✘ Extend and lay out the torch hose package
- ↘ Wire guide core or spiral is dirty or worn
  - ✘ Clean core or spiral; replace kinked or worn cores

#### Functional errors

- ↘ All machine control signal lights are illuminated after switching on
- ↘ No machine control signal light is illuminated after switching on
- ↘ No welding power
  - ✘ Phase failure > check mains connection (fuses)
- ↘ Various parameters cannot be set
  - ✘ Entry level is blocked, disable access lock
- ↘ Connection problems
  - ✘ Make control lead connections and check that they are fitted correctly.
- ↘ Loose welding current connections
  - ✘ Tighten power connections on the torch and/or on the workpiece
  - ✘ Tighten contact tip correctly

### 7.2 Vent coolant circuit

- Coolant tank and quick connect coupling of coolant supply and return are only fitted in machines with water cooling.**
- To vent the cooling system always use the blue coolant connection, which is located as deep as possible inside the system (close to the coolant tank)!**

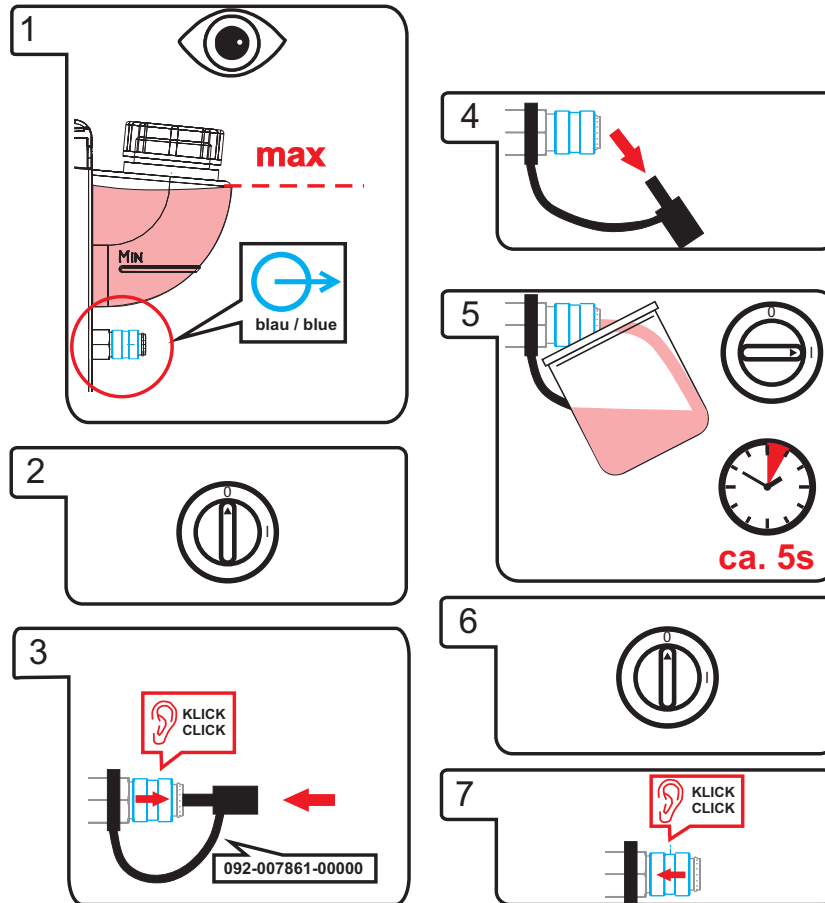

Figure 7-1



## 8 Technical data

 *Performance specifications and guarantee only in connection with original spare and replacement parts!*

### 8.1 miniDrive

Supply voltage	60 VDC
Max. welding current (100% DC)	300 A
Max. welding current (60% DC)	400 A
Wire feed speed	1 m/min to 20 m/min
Standard roller installation	1.0 + 1.2 mm (for steel wire)
Drive rollers	37 mm
Welding torch connection	Euro torch connector
Protection classification	IP 23
Ambient temperature	-25 °C to +40 °C
Dimensions L x W x H in mm	300 x 180 x 200
Weight exl. hose package	7.5 kg
EMC class	A
Constructed to standard	IEC 60974-1, -5, -10 S / C E

## 9 Accessories



*Performance-dependent accessories like torches, workpiece leads, electrode holders or intermediate hose packages are available from your authorised dealer.*

### 9.1 Remote control / connection cable

Type	Designation	Item no.
R10 19POL	Remote control	090-008087-00000
RG10 19POL 5M	Remote control to set the wire speed and welding voltage correction	090-008108-00000
R20 19POL	Program changeover remote control	090-008263-00000
RA5 19POL 5M	Remote control e.g. connection cable	092-001470-00005
RA10 19POL 10M	Remote control e.g. connection cable	092-001470-00010

### 9.2 General accessories

Type	Designation	Item no.
SPL	Sharpener for plastic liners	094-010427-00000
HC PL	Hose cutter	094-016585-00000

## 10 Replaceable parts

### CAUTION



**Damage due to the use of non-genuine parts!**

**The manufacturer's warranty becomes void if non-genuine parts are used!**

- Only use system components and options (power sources, welding torches, electrode holders, remote controls, spare parts and replacement parts, etc.) from our range of products!
- Only insert and lock accessory components into the relevant connection socket when the machine is switched off.

### 10.1 Conversion kit

Type	Designation	Item no.
URUE AL 2R 10m miniDrive	Conversion kit for aluminium consisting of two drive pinions, liner and mounting material	092-007906-00010
URUE AL 2R 15m miniDrive	Conversion kit for aluminium consisting of two drive pinions, liner and mounting material	092-007906-00015
URUE ROE 2R miniDrive	Conversion kit for flux cored wire consisting of two drive pinions and mounting material	092-003131-00000

### 10.2 Wire feed rollers

#### 10.2.1 Wire feed rollers for steel wire

Type	Designation	Item no.
FE 1DR2R 0.8+1.0	Drive rollers, 37mm, steel	094-003218-00000
FE 1DR2R 0.9+1.2	Drive rollers, 37mm, steel	094-003221-00000
FE 1DR2R 1.0+1.2	Drive rollers, 37mm, steel	094-003219-00000
FE 1DR2R 1,2+1,6	Drive rollers, 37 mm, steel	094-003220-00000
FE GR2R	Pressure roller, smooth, 37 mm	092-007908-00000

#### 10.2.2 Wire feed rollers for aluminium wire

Type	Designation	Item no.
AL 2ZR2R 1,2+1,6	Twin wire feed rollers, 37 mm, for aluminium	092-000829-00000

#### 10.2.3 Wire feed rollers for cored wire

Type	Designation	Item no.
ROE 1DR2R 0,8/0,9+0,8/0,9	Drive roll, 37 mm, flux cored wire	094-003229-00000
ROE 1DR2R 1,0/1,2+1,4/1,6	Drive roller, 37 mm, flux cored wire	094-003233-00000
ROE 1DR2R 1,4/1,6+2,0/2,4	Drive roller, 37 mm, flux cored wire	094-003234-00000
ROE 1DR2R 2,8+3,2	Drive roller, 37 mm, flux cored wire	094-003230-00000
ROE GR2R	Pressure roll, knurled, 37 mm	094-005319-00000

<p><b>Verschleißteile</b> 2 Rollen-Antrieb Ø = 37mm St= Stahl Al= Aluminium CrNi= Edelstahl Cu= Kupfer</p> <p><b>D</b></p>	<p><b>V-Nut:</b> <b>St-, CrNi-, Cu-Draht</b> „Standard V-Nut“ oben unverzahnt und glatt</p> <p>Antriebsrollen- Ø (b): <b>Drive rolls- Ø (b):</b> 0,8 + 1,0 0,9 + 1,2 1,0 + 1,2 1,2 + 1,6</p> <p>Ersatzteil: <b>Spare part:</b> 094-003218-00000 094-003221-00000 094-003219-00000 094-003220-00000</p> <p> Gegendruckrolle (a) counter pressure roll (a) 092-007908-00000</p>	<p><b>U-Nut:</b> <b>Al-, Cu-Draht</b> „Option U-Nut“ oben verzahnt</p> <p>Antriebsrollen- Ø (a+b): <b>Drive rolls- Ø (a+b):</b> 1,2 + 1,6</p> <p>Ersatzteil: <b>Spare part:</b> 092-000829-00000</p> <p> Umrüstset: <b>Conversion set:</b> 092-007906-00010 092-007906-00015</p>	<p><b>U-Nut gerändelt:</b> <b>Füll-/Röhrchendraht</b> „Option U-Nut gerändelt“ oben verzahnt ohne Nut gerändelt</p> <p>Antriebsrollen- Ø (b): <b>Drive rolls- Ø (b):</b> 0,8 / 0,9 + 0,8 / 0,9 1,0 / 1,2 + 1,4 / 1,6</p> <p>Ersatzset: <b>Spare set:</b> 094-003229-000000 094-003233-000000</p> <p> Umrüstset: <b>Conversion set:</b> 092-003131-00000 Gegendruckrolle (a) counter pressure roll (a) 094-005319-00000</p>
	<p><b>Wear parts</b> 2-Roller drive system Ø = 37mm St= Steel Al= Aluminium CrNi= Stainless steel Cu= Copper</p> <p><b>GB</b></p>	<p><b>V-groove:</b> <b>St-, CrNi-, Cu wire</b> "Standard V-groove" on the top ungeared and plane</p>	<p><b>U-groove:</b> <b>Al-, Cu wire</b> "Option U-groove" on the top geared-twin rolls</p>

Figure 10-1

## 11 Appendix A

### 11.1 Circuit diagram – cable adapter

**DANGER**

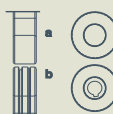
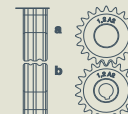
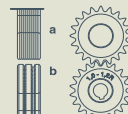
**Do not carry out any unauthorised repairs or modifications!**

**To avoid injury and equipment damage, the unit must only be repaired or modified by specialist, skilled persons!**

**The warranty becomes null and void in the event of unauthorised interference.**

- Appoint only skilled persons for repair work (trained service personnel)!

**Configuration**

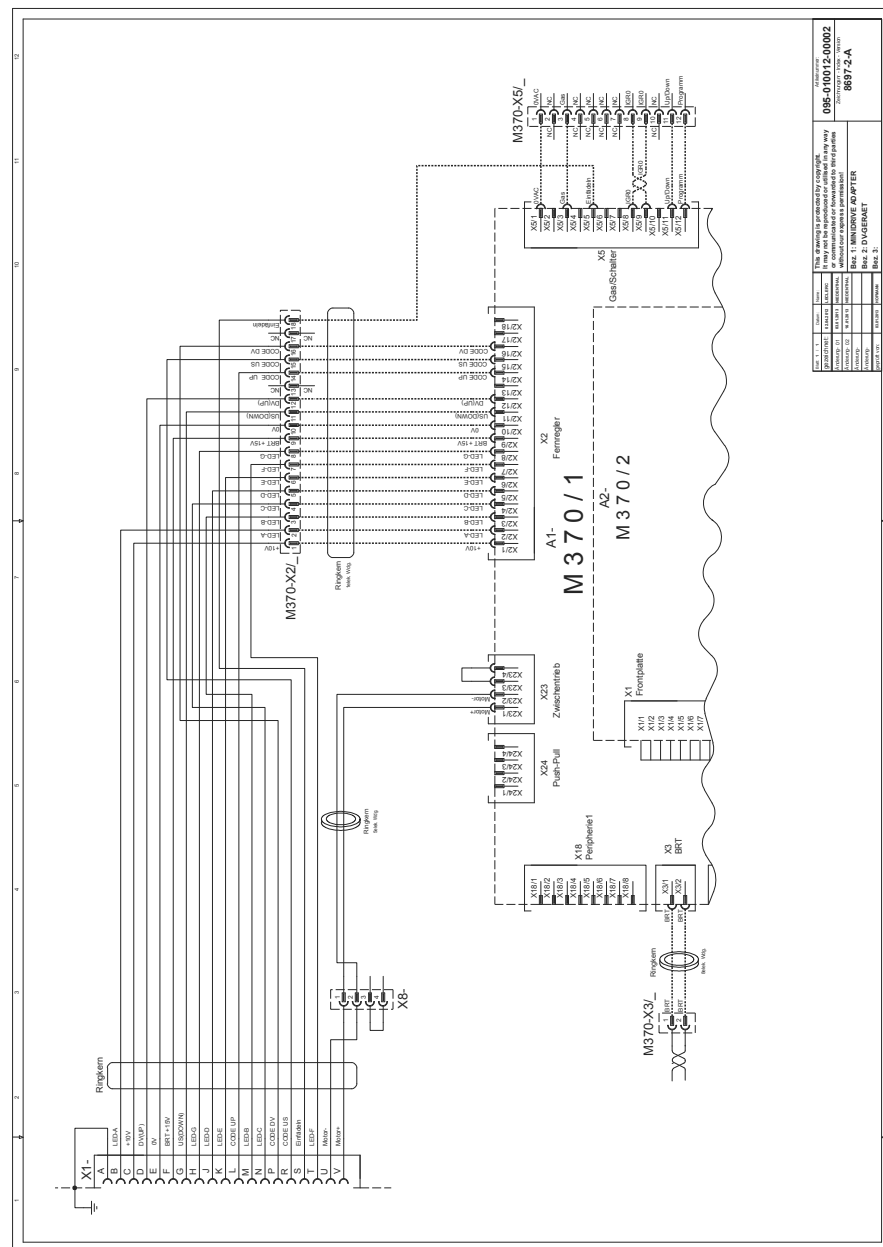

Figure 11-1

## 12 Appendix B

### 12.1 Overview of EWM branches

#### Headquarters

**EWM AG**  
Dr. Günter-Henle-Straße 8  
56271 Mündersbach · Germany  
Tel: +49 2680 181-0 · Fax: -244  
www.ewm-group.com · info@ewm-group.com

#### Technology centre

**EWM AG**  
Forststraße 7-13  
56271 Mündersbach · Germany  
Tel: +49 2680 181-0 · Fax: -144  
www.ewm-group.com · info@ewm-group.com



#### Production, Sales and Service

**EWM AG**  
Dr. Günter-Henle-Straße 8  
56271 Mündersbach · Germany  
Tel: +49 2680 181-0 · Fax: -244  
www.ewm-group.com · info@ewm-group.com

**EWM HIGHTEC WELDING s.r.o.**  
9. května 718 / 31  
407 53 Jiríkov · Czech Republic  
Tel.: +420 412 358-551 · Fax: -504  
www.ewm-jirikov.cz · info@ewm-jirikov.cz

**EWM HIGH TECHNOLOGY (Kunshan) Ltd.**  
10 Yuanshan Road, Kunshan · New & Hi-tech Industry Development Zone  
Kunshan City · Jiangsu · Post code 215300 · People's Republic of China  
Tel: +86 512 57867-188 · Fax: -182  
www.ewm.cn · info@ewm.cn · info@ewm-group.cn

#### Sales and Service Germany

**EWM AG**  
Sales and Technology Centre  
Grünauer Fenn 4  
14712 Rathenow · Tel: +49 3385 49402-0 · Fax: -20  
www.ewm-rathenow.de · info@ewm-rathenow.de

**EWM HIGHTEC WELDING GmbH**  
Sales and Technology Centre  
Draisstraße 2a  
69469 Weinheim · Tel: +49 6201 84557-0 · Fax: -20  
www.ewm-weinheim.de · info@ewm-weinheim.de

**EWM AG**  
Rudolf-Winkel-Straße 7-9  
37079 Göttingen · Tel: +49 551-3070713-0 · Fax: -20  
www.ewm-goettingen.de · info@ewm-goettingen.de

**EWM Schweißtechnik Handels GmbH**  
Karlsdorfer Straße 43  
88069 Tettngang · Tel: +49 7542 97998-0 · Fax: -29  
www.ewm-tettngang.de · info@ewm-tettngang.de

**EWM AG**  
Sachsstraße 28  
50259 Pulheim · Tel: +49 2234 697-047 · Fax: -048  
www.ewm-pulheim.de · info@ewm-pulheim.de

**EWM Schweißtechnik Handels GmbH**  
Heinkelstraße 8  
89231 Neu-Ulm · Tel: +49 731 7047939-0 · Fax: -15  
www.ewm-neu-ulm.de · info@ewm-neu-ulm.de

**EWM AG**  
August-Horch-Straße 13a  
56070 Koblenz · Tel: +49 261 963754-0 · Fax: -10  
www.ewm-koblenz.de · info@ewm-koblenz.de

**EWM AG**  
Eiserfelder Straße 300  
57080 Siegen · Tel: +49 271 3878103-0 · Fax: -9  
www.ewm-siegen.de · info@ewm-siegen.de

#### Sales and Service International

**EWM HIGH TECHNOLOGY (Kunshan) Ltd.**  
10 Yuanshan Road, Kunshan · New & Hi-tech Industry Development Zone  
Kunshan City · Jiangsu · Post code 215300 · People's Republic of China  
Tel: +86 512 57867-188 · Fax: -182  
www.ewm.cn · info@ewm.cn · info@ewm-group.cn

**EWM HIGHTEC WELDING UK Ltd.**  
Unit 2B Coopies Way · Coopies Lane Industrial Estate  
Morpeth · Northumberland · NE61 6JN · Great Britain  
Tel: +44 1670 505875 · Fax: -514305  
www.ewm-morpeth.co.uk · info@ewm-morpeth.co.uk

**EWM HIGHTEC WELDING GmbH**  
Wiesenstraße 27b  
4812 Pinsdorf · Austria · Tel: +43 7612 778 02-0 · Fax: -20  
www.ewm-austria.at · info@ewm-austria.at

**EWM HIGHTEC WELDING Sales s.r.o. / Prodejní a poradenské centrum**  
Tyršova 2106  
256 01 Benešov u Prahy · Czech Republic  
Tel: +420 317 729-517 · Fax: -712  
www.ewm-benesov.cz · info@ewm-benesov.cz

#### Liaison office Turkey

**EWM AG Türkiye İrtibat Bürosu**  
İkitelli OSB Mah. · Marmara Sanayi Sitesi P Blok Apt. No: 44  
Küçükçekmece / İstanbul Türkiye  
Tel.: +90 212 494 32 19  
www.ewm-istanbul.com.tr · info@ewm-istanbul.com.tr

