



EN

Control

LP-XQ (M3.7X-J)

099-00LPXQ-EW501

Observe additional system documents!

13.03.2018

**Register now
and benefit!
Jetzt Registrieren
und Profitieren!**

www.ewm-group.com



General instructions

WARNING



Read the operating instructions!

The operating instructions provide an introduction to the safe use of the products.

- Read and observe the operating instructions for all system components, especially the safety instructions and warning notices!
- Observe the accident prevention regulations and any regional regulations!
- The operating instructions must be kept at the location where the machine is operated.
- Safety and warning labels on the machine indicate any possible risks. Keep these labels clean and legible at all times.
- The machine has been constructed to state-of-the-art standards in line with any applicable regulations and industrial standards. Only trained personnel may operate, service and repair the machine.
- Technical changes due to further development in machine technology may lead to a differing welding behaviour.



In the event of queries on installation, commissioning, operation or special conditions at the installation site, or on usage, please contact your sales partner or our customer service department on +49 2680 181-0.

A list of authorised sales partners can be found at www.ewm-group.com/en/specialist-dealers.

Liability relating to the operation of this equipment is restricted solely to the function of the equipment. No other form of liability, regardless of type, shall be accepted. This exclusion of liability shall be deemed accepted by the user on commissioning the equipment.

The manufacturer is unable to monitor whether or not these instructions or the conditions and methods are observed during installation, operation, usage and maintenance of the equipment.

An incorrectly performed installation can result in material damage and injure persons as a result. For this reason, we do not accept any responsibility or liability for losses, damages or costs arising from incorrect installation, improper operation or incorrect usage and maintenance or any actions connected to this in any way.

© EWM AG

Dr. Günter-Henle-Strasse 8

56271 Mündersbach Germany

Tel.: +49 2680 181-0, Fax: -244

Email: info@ewm-group.com

www.ewm-group.com

The copyright to this document remains the property of the manufacturer.

Copying, including extracts, only permitted with written approval.

The content of this document has been prepared and reviewed with all reasonable care. The information provided is subject to change; errors excepted.

1 Contents

1	Contents	3
2	For your safety	7
2.1	Notes on the use of these operating instructions	7
2.2	Explanation of icons.....	8
2.3	Part of the complete documentation	9
3	Intended use	10
3.1	Use and operation solely with the following machines	10
3.2	Documents which also apply	10
3.3	Software version	10
4	Machine control – Operating elements	11
4.1	Overview of control sections	11
4.1.1	Control section A	12
4.1.2	Control section B	14
4.2	Welding data display	16
4.3	Operating the machine control.....	17
4.3.1	Main screen	17
4.3.2	Welding power setting	17
4.3.3	Changing basic settings (machine configuration menu)	17
4.3.4	Lock function	17
5	Functional characteristics	18
5.1	Shielding gas volume settings	18
5.1.1	Gas test	18
5.1.2	Purge hose package.....	18
5.2	Wire thread	19
5.3	Wire return	19
5.4	MIG/MAG welding.....	20
5.4.1	Welding task selection.....	20
5.4.1.1	Basic welding parameters.....	20
5.4.1.2	Welding procedure	20
5.4.1.3	Operating mode	21
5.4.1.4	Welding type	21
5.4.1.5	Welding power (operating point)	22
5.4.1.6	Accessory components for operating point setting	22
5.4.1.7	Arc length	22
5.4.1.8	Arc dynamics (choke effect).....	23
5.4.2	Programs (P _A 1-15)	23
5.4.2.1	Selection and adjustment.....	23
5.4.3	Program sequence	25
5.4.4	Operating modes (functional sequences)	26
5.4.4.1	Explanation of signs and functions	26
5.4.4.2	Automatic cut-out	26
5.4.5	forceArc / forceArc puls	33
5.4.6	wiredArc.....	34
5.4.7	rootArc/rootArc puls.....	34
5.4.8	coldArc / coldArc puls	35
5.4.9	Standard MIG/MAG torch.....	35
5.4.10	MIG/MAG special-torches	35
5.4.10.1	Program and up/down operation.....	35
5.4.10.2	Switching between Push/Pull and intermediate drive	36
5.5	TIG welding.....	36
5.5.1	Welding task selection.....	36
5.5.1.1	Welding current setting	36
5.5.2	TIG arc ignition	37
5.5.2.1	Liftarc	37
5.5.3	Operating modes (functional sequences)	38
5.5.3.1	Explanation of signs and functions	38
5.5.3.2	Automatic cut-out	38
5.6	MMA welding	41

5.6.1	Welding task selection	41
5.6.1.1	Welding current setting.....	42
5.6.2	Arcforce.....	42
5.6.3	Hotstart	42
5.6.4	Antistick.....	42
5.7	Options (additional components)	43
5.7.1	Electronic gas flow control (OW DGC)	43
5.7.2	Wire reserve sensor (OW WRS)	43
5.7.3	Wire spool heater (OW WHS)	43
5.8	Access control.....	43
5.9	Voltage reducing device.....	43
5.10	Special parameters (advanced settings).....	43
5.10.1	Selecting, changing and saving parameters.....	44
5.10.1.1	Ramp time for wire inching (P1).....	46
5.10.1.2	Program "0", releasing the program block (P2).....	47
5.10.1.3	Display mode for Up/Down welding torch with one-digit 7-segment display (P3)	47
5.10.1.4	Program limit (P4)	47
5.10.1.5	Special cycle in the operating modes special latched and non-latched (P5).....	47
5.10.1.6	Correction operation, threshold value setting (P7).....	48
5.10.1.7	Switching programs with the standard torch trigger (P8).....	49
5.10.1.8	Latched/special-latched tap start (P9).....	50
5.10.1.9	"Single or dual operation" (P10) setting	50
5.10.1.10	Latched special tapping time setting (P11)	50
5.10.1.11	JOB list switching (P12)	51
5.10.1.12	Lower and upper limits of the remote JOB changeover process (P13, P14).....	51
5.10.1.13	Hold function (P15).....	51
5.10.1.14	Block JOB mode (P16).....	52
5.10.1.15	Selecting programs with the standard torch trigger (P17).....	52
5.10.1.16	Mean value display for superPuls (P19)	52
5.10.1.17	Predefined execution of the pulsed arc welding process in the PA program (P20)	53
5.10.1.18	Predefined absolute value for relative programs (P21).....	53
5.10.1.19	Electronic gas flow control, type (P22).....	53
5.10.1.20	Program settings for relative programs (P23)	53
5.10.1.21	Correction or nominal voltage display (P24)	53
5.10.1.22	JOB selection in Expert mode (P25)	53
5.10.1.23	Nominal value wire heater (P26).....	53
5.10.1.24	Mode switching at welding start (P27)	53
5.10.1.25	Error threshold electronic gas flow control (P28)	53
5.10.1.26	Units system (P29)	53
5.10.1.27	Selection option – Program sequence with welding power rotary knob (P30).....	53
5.10.2	Reset to factory settings	54
5.11	Machine configuration menu	54
5.11.1	Selecting, changing and saving parameters.....	54
5.11.2	Aligning the cable resistance	56
5.11.3	Power-saving mode (Standby)	57
6	Rectifying faults.....	58
6.1	Display machine control software version.....	58
6.2	Error messages (power source).....	58
6.3	Warnings	60
6.4	Resetting JOBS (welding tasks) to the factory settings.....	61
6.4.1	Resetting a single JOB	61
6.4.2	Resetting all JOBS	61
7	Appendix A.....	62
7.1	JOB-List.....	62

8 Appendix B	69
8.1 Parameter overview – setting ranges	69
8.1.1 MIG/MAG welding	69
8.1.2 MMA welding	69
9 Appendix C	70
9.1 Searching for a dealer	70

2 For your safety

2.1 Notes on the use of these operating instructions

DANGER

Working or operating procedures which must be closely observed to prevent imminent serious and even fatal injuries.

- Safety notes include the "DANGER" keyword in the heading with a general warning symbol.
- The hazard is also highlighted using a symbol on the edge of the page.

WARNING

Working or operating procedures which must be closely observed to prevent serious and even fatal injuries.

- Safety notes include the "WARNING" keyword in the heading with a general warning symbol.
- The hazard is also highlighted using a symbol in the page margin.

CAUTION

Working or operating procedures which must be closely observed to prevent possible minor personal injury.

- The safety information includes the "CAUTION" keyword in its heading with a general warning symbol.
- The risk is explained using a symbol on the edge of the page.



Technical aspects which the user must observe to avoid material or equipment damage.

Instructions and lists detailing step-by-step actions for given situations can be recognised via bullet points, e.g.:

- Insert the welding current lead socket into the relevant socket and lock.

2.2 Explanation of icons

Symbol	Description
	Indicates technical aspects which the user must observe.
	Switch off machine
	Switch on machine
	Incorrect / Invalid
	Correct / Valid
	Input
	Navigation
	Output
	Time representation (e.g.: wait 4 s / actuate)
	Interruption in the menu display (other setting options possible)
	Tool not required/do not use
	Tool required/use

Symbol	Description
	Activate and release / Tap / Tip
	Release
	Press and hold
	Switch
	Turn
	Numerical value – adjustable
	Signal light lights up in green
	Signal light flashes green
	Signal light lights up in red
	Signal light flashes red

2.3 Part of the complete documentation

 **These operating instructions are part of the complete documentation and valid only in combination with all other parts of these instructions! Read and observe the operating instructions for all system components, especially the safety instructions!**

The illustration shows a general example of a welding system.

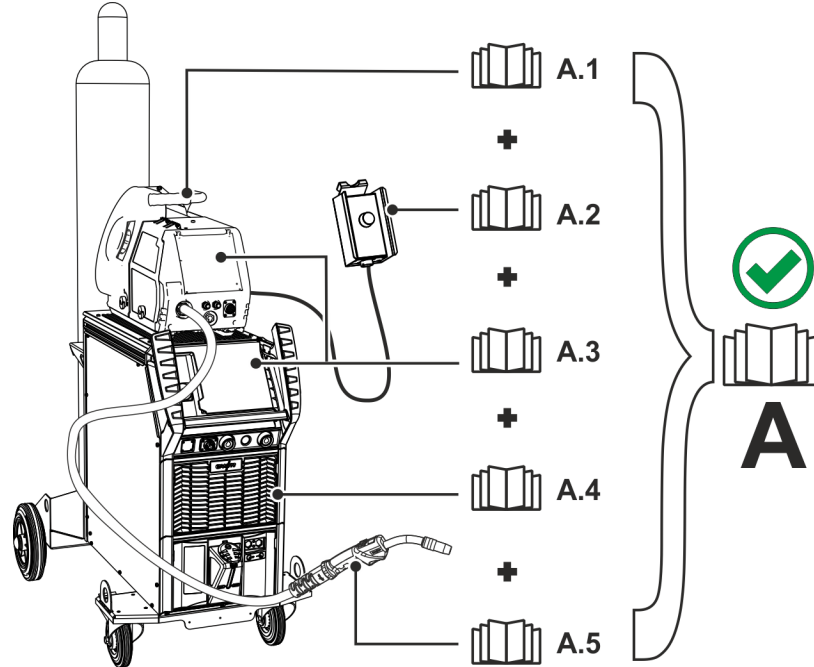

Figure 2-1

The illustration shows a general example of a welding system.

Item	Documentation
A.1	Wire feeder
A.2	Remote adjuster
A.3	Controller
A.4	Power source
A.5	Welding torch
A	Complete documentation

3 Intended use

WARNING



Hazards due to improper usage!

The machine has been constructed to the state of the art and any regulations and standards applicable for use in industry and trade. It may only be used for the welding procedures indicated at the rating plate. Hazards may arise for persons, animals and material objects if the equipment is not used correctly. No liability is accepted for any damages arising from improper usage!

- The equipment must only be used in line with its designated purpose and by trained or expert personnel!
- Do not improperly modify or convert the equipment!

3.1 Use and operation solely with the following machines

Diese Beschreibung darf ausschließlich auf Geräte mit Gerätesteuerung M3.7X-J angewendet werden.

3.2 Documents which also apply

- Operating instructions for the connected welding machines
- Documents of the optional expansions

3.3 Software version

These instructions apply to the following software version:

1.0.9.0



The software version of the machine control can be displayed in the machine configuration menu (menu Srv) > see 5.11 chapter.

4 Machine control – Operating elements

4.1 Overview of control sections

For description purposes, the machine control has been divided into two sections (A, B) to ensure maximum clarity. The setting ranges for the parameter values are summarised in the parameter overview section > see 8.1 chapter.

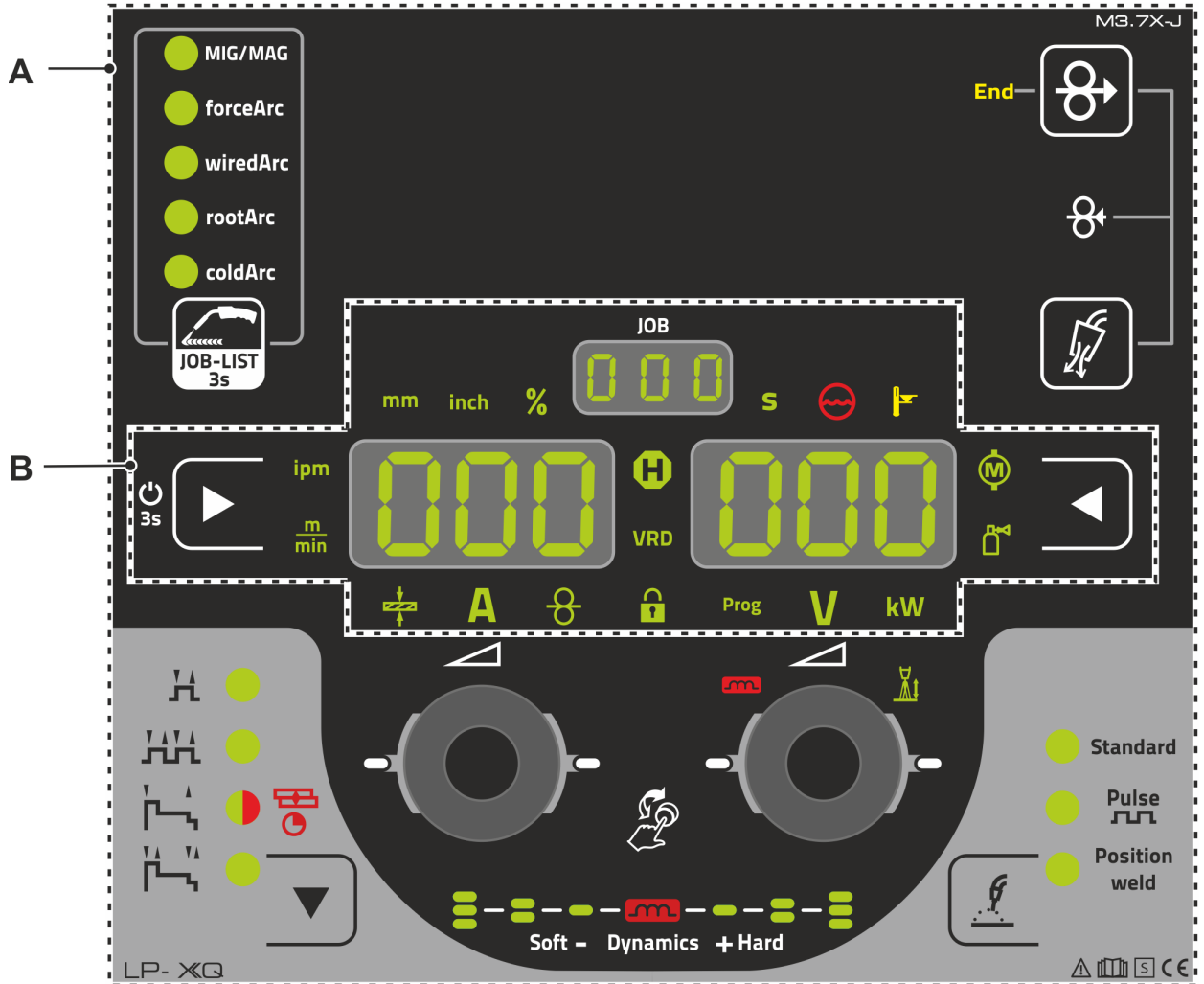

Figure 4-1

Item	Symbol	Description
1		Control section A > see 4.1.1 chapter
2		Control section B > see 4.1.2 chapter

4.1.1 Control section A

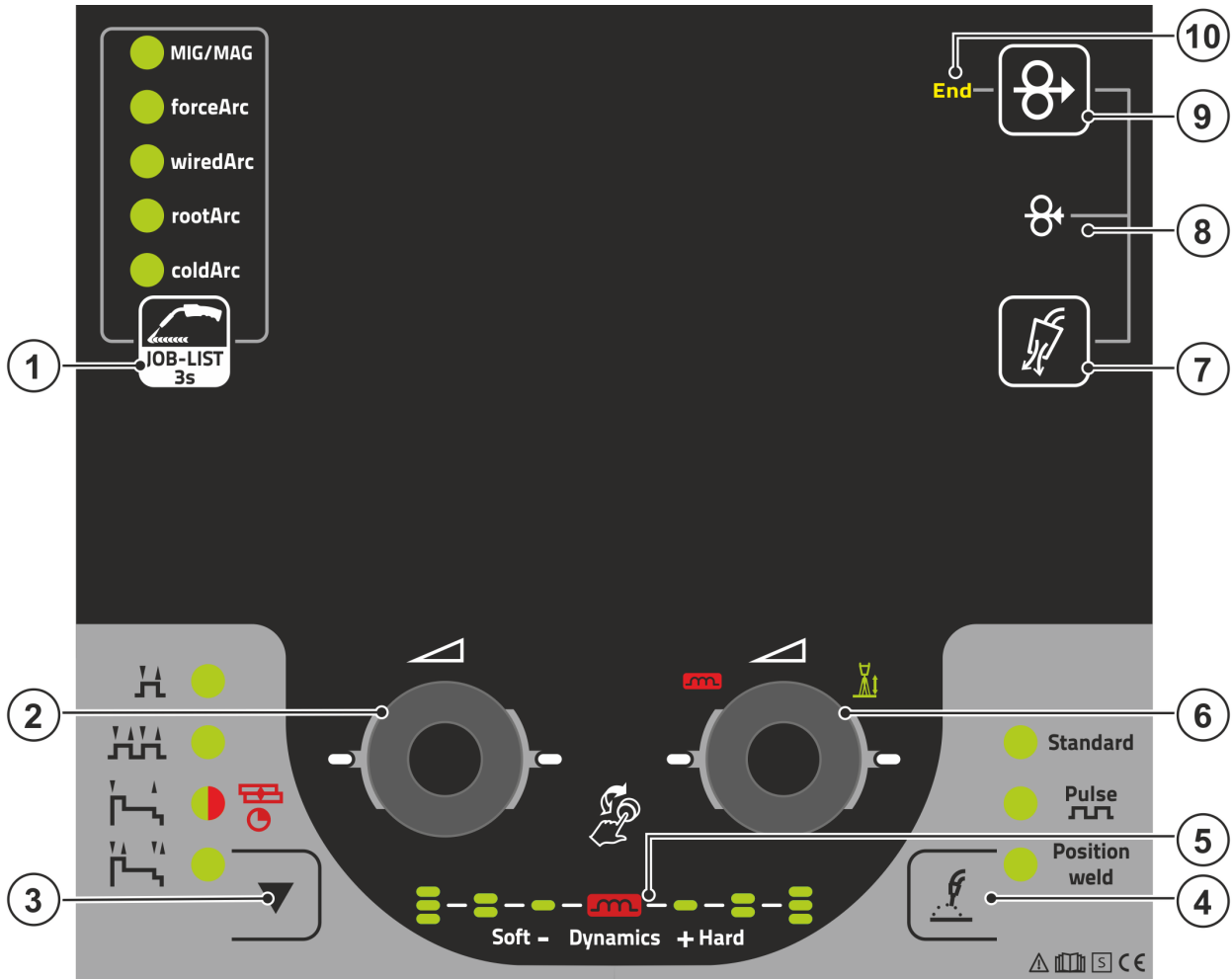





Figure 4-2

Item	Symbol	Description
1		Welding task push-button (JOB) <ul style="list-style-type: none"> ----- Pressing the push-button briefly: Fast switching of the available welding procedures in the selected basic parameters (material/wire/gas). ----- Pressing the push-button longer: Select the welding task (JOB) from the welding task list (JOB-LIST) > see 5.4.1 chapter. The list can be found inside the protective cap on the wire feeder and in the appendix to these operating instructions.
2		Click wheel welding power <ul style="list-style-type: none"> ----- Setting the welding power > see 4.3.2 chapter ----- Setting various parameters values depending on the preselection. The white signal lights (LED) around the rotary knob light up when setting is possible.
3		Operating modes push-button (functional sequences) > see 5.4.4 chapter <ul style="list-style-type: none"> ----- Non-latched ----- Latched ----- Signal light turns green: Special non-latched ----- Signal light turns red: MIG spots ----- Special latched
4		Push-button, welding type <ul style="list-style-type: none"> ----- Standard: Welding with standard arc ----- Pulses: Welding with pulsed arc ----- Positionweld: Positional welding
5		Display of arc dynamics <p>The height and orientation of the set arc dynamics are displayed.</p>

Item	Symbol	Description
6		Correction of arc length click wheel <ul style="list-style-type: none"> •----- Setting the arc length correction > see 5.4.1.7 chapter •----- Setting arc dynamics > see 5.4.1.8 chapter •----- Setting various parameters values depending on the preselection. The white signal lights (LED) around the rotary knob light up when setting is possible.
7		Push-button shielding gas supply > see 5.1 chapter <ul style="list-style-type: none"> •----- Gas test •----- Purge hose package
8		Wire return > see 5.3 chapter Potential and gas-free return of the wire electrode.
9		Wire inching push-button Potential and gas-free inching of the wire electrode > see 5.2 chapter.
10	End	Signal light wire reserve sensor (ex works option) > see 5.7.2 chapter Lights up when the welding wire is less than approx. 10% residual quantity.

4.1.2 Control section B

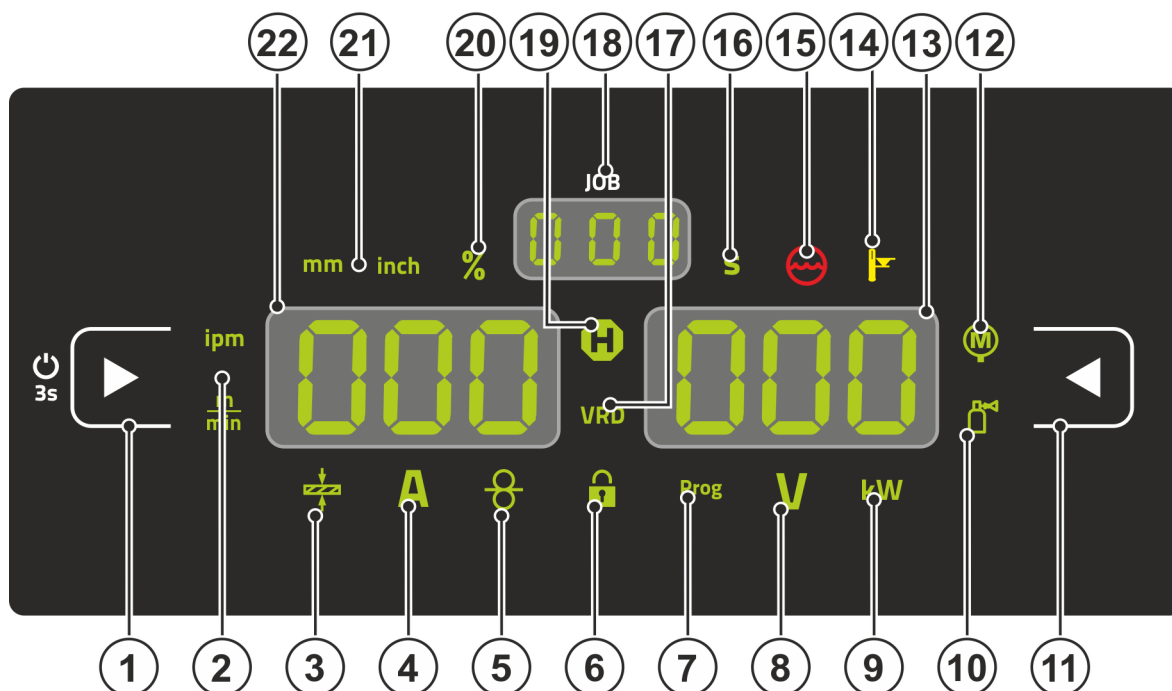









Figure 4-3

Item	Symbol	Description
1		Display left / Lock function push-button Switching the device display between various welding parameters. Signal lamps show the selected parameter. ⏻----- Press for 3 s to put the machine into lock function > see 4.3.4 chapter.
2		Wire feed speed unit signal light m/min --- Parameter value is displayed in meters per minute. ipm ----- Parameter value is displayed in inches per minute. Switching between metric or imperial system via special parameters "P29" > see 5.10 chapter.
3		Material thickness signal light Indication of the selected material thickness.
4	A	Welding current signal light Display of the welding current in amperes.
5		Signal light, Wire speed Lights when the wire speed is shown on the display.
6		Lock function signal light Use display left / lock function push-button to switch on and off.
7	Prog	Signal light program Display of the current program number in the welding data display.
8	V	Correction voltage arc length signal light Display of correction voltage arc length in volts.
9	kW	Welding power signal light Display of welding power in kilowatts.
10		Electronic gas flow control signal light OW DGC > see 5.7.1 chapter Shows the gas flow rate in the device display.
11		Display push-button, right Primary display of arc length correction and other parameters and their values.

Item	Symbol	Description
12		Motor current signal light During wire inching, the current motor current (wire feed mechanism) is displayed in amperes.
13		Display right - Primary display of welding voltage This display shows the welding voltage, arc length correction, programs or welding power (switching by Display right push-button). Furthermore, dynamics and, depending on the preselection, various welding parameter values are displayed. Parameter times or hold values > see 4.2 chapter.
14		Excess temperature signal light / Welding torch cooling failure For error messages > see 6 chapter
15		Coolant fault signal light Indicates flow fault or low coolant level.
16		Second signal light The displayed value is displayed in seconds.
17	VRD	Voltage reduction device (VRD) signal light > see 5.9 chapter
18		JOB number display (welding task) > see 5.4.1 chapter
19		Status display signal light (Hold) Display of mean values across the entire welding process.
20	%	Percent signal light The displayed value is displayed in percent.
21		Material thickness unit signal light mm ----- Parameter value is displayed in millimeters. inch ----- Parameter value is displayed in inches. Switching between metric or imperial system via special parameters "P29" > see 5.10 chapter.
22		Display left - Primary display of welding power This display shows the welding power either as wire feed speed, welding current or material thickness (switching by display push-button on the left). Furthermore, depending on the preselection, various welding parameter values are displayed. Parameter times or hold values > see 4.2 chapter.

4.2 Welding data display

On the left and right of the parameter displays there are push-buttons for the selection of parameters. They are used to select the welding parameters to be displayed and their values.

Each time one the button is clicked, the display proceeds to the next parameter (signal lights indicate the selection). After reaching the last parameter, the system is restarted with the first one.

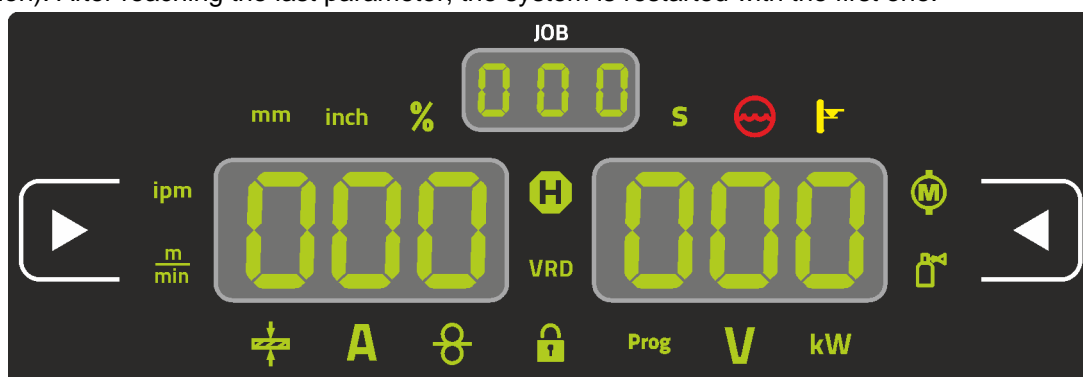

Figure 4-4

MIG/MAG

Parameter	Nominal values ^[1]	Actual values ^[2]	Hold values ^[3]
Welding current	✓	✓	✓
Material thickness	✓	✗	✗
Wire feed speed	✓	✓	✓
Welding voltage	✓	✓	✓
Welding power	✗	✓	✓
Motor current	✗	✓	✗
Shielding gas	✓	✓	✗

TIG

Parameter	Nominal values ^[1]	Actual values ^[2]	Hold values ^[3]
Welding current	✓	✓	✓
Welding voltage	✓	✓	✓
Welding power	✗	✓	✓
Shielding gas	✓	✓	✗

MMA

Parameter	Nominal values ^[1]	Actual values ^[2]	Hold values ^[3]
Welding current	✓	✓	✗
Welding voltage	✓	✓	✗
Welding power	✗	✓	✗

When settings are changed (e.g. wire feed speed) the display immediately switches to nominal value setting.

^[1] Nominal values (before welding)

^[2] Actual values (during welding)

^[3] Hold values (after welding, display of mean values across entire welding process)

4.3 Operating the machine control

4.3.1 Main screen

The machine control switches to the main screen after it has been turned on or a setting has been completed. This means that the previously selected settings (indicated by signal lights where applicable) and the nominal value for the current (A) are displayed in the left-hand welding data display. Depending on the selection, the right-hand display shows the welding voltage (V) nominal value or the welding power (kW) actual value. The control always switches back to the main screen after 4 sec..

4.3.2 Welding power setting

The welding power is adjusted with the welding power rotary knob (click wheel). You can also adjust the parameters in the operation sequence or settings in the different machine menus.

4.3.3 Changing basic settings (machine configuration menu)

The basic welding system functions can be adjusted in the machine configuration menu. Only experienced users should change the settings > see 5.11 chapter.

4.3.4 Lock function

The lock function protects against accidental adjustment of the device settings.

The user can switch the lock function on or off by pressing the button for a long time from each machine control or accessory component with the symbol .

5 Functional characteristics

5.1 Shielding gas volume settings

If the shielding gas setting is too low or too high, this can introduce air to the weld pool and may cause pores to form. Adjust the shielding gas quantity to suit the welding task!

- Slowly open the gas cylinder valve.
- Open the pressure regulator.
- Switch on the power source at the main switch.
- Trigger gas test > see 5.1.1 chapter function (welding voltage and wire feed motor remain switched off – no accidental arc ignition).
- Set the relevant gas quantity for the application on the pressure regulator.

Setting instructions

Welding process	Recommended shielding gas quantity
MAG welding	Wire diameter x 11.5 = l/min
MIG brazing	Wire diameter x 11.5 = l/min
MIG welding (aluminium)	Wire diameter x 13.5 = l/min (100 % argon)
TIG	Gas nozzle diameter in mm corresponds to l/min gas throughput

Helium-rich gas mixtures require a higher gas volume!

The table below can be used to correct the gas volume calculated where necessary:

Shielding gas	Factor
75% Ar/25% He	1.14
50% Ar/50% He	1.35
25% Ar/75% He	1.75
100% He	3.16

5.1.1 Gas test

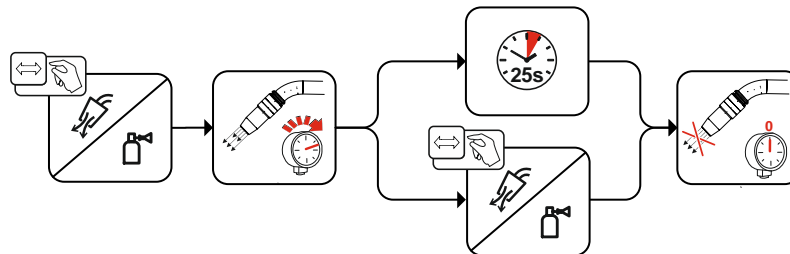

Figure 5-1

5.1.2 Purge hose package

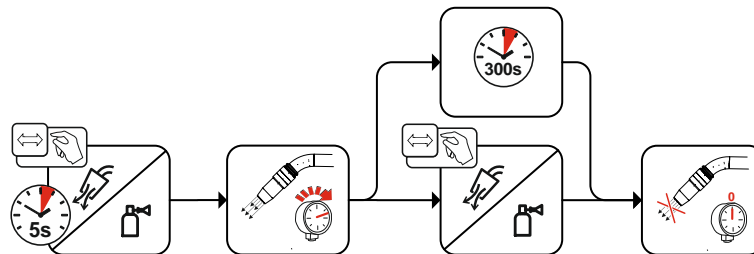

Figure 5-2

5.2 Wire thread

The wire inching function is used for potential- and gas-free inching of the wire electrode after the wire spool change. By pressing and holding the wire inching button for a long time, the wire inching speed increases in a ramp function (special parameter P1 > see 5.10.1.1 chapter) from 1 m/min to the set maximum value. The maximum value is set by simultaneously pressing the wire inching button and turning the left click wheel.

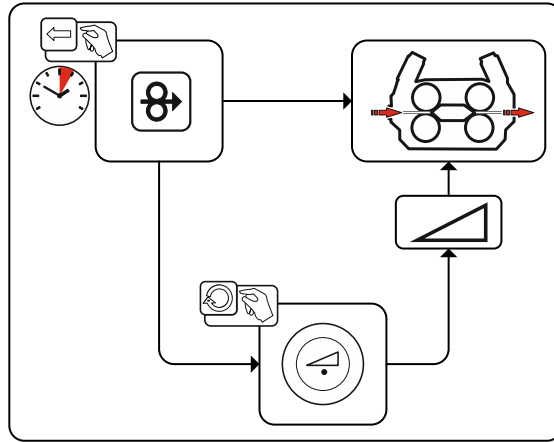

Figure 5-3

5.3 Wire return

The wire return function is used to retract the wire electrode without tension and protection gas. By simultaneously pressing and holding the wire inching and gas test buttons, the wire return speed increases in a ramp function (special parameter P1 > see 5.10.1.1 chapter) from 1 m/min to the set maximum value. The maximum value is set by simultaneously pressing the wire inching button and turning the left click wheel.

During the process, the wire spool must be turned by hand clockwise to wind up the wire electrode again.

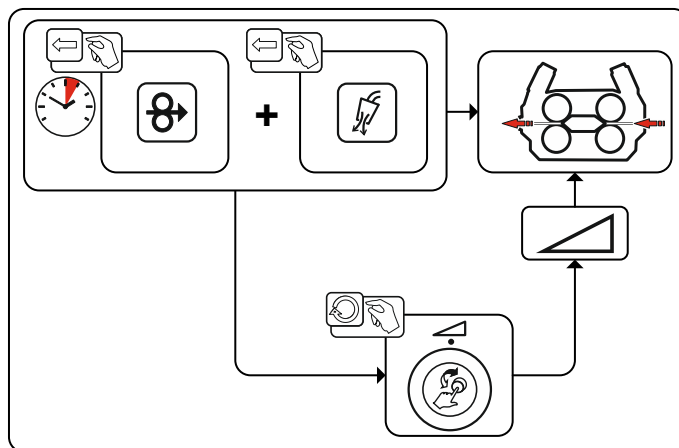

Figure 5-4

5.4 MIG/MAG welding

5.4.1 Welding task selection

Zur Schweißaufgabenwahl sind folgende Schritte durchzuführen:

- Grundparameter (Materialart, Drahtdurchmesser und Schutzgasart) und Schweißverfahren wählen (JOB-Nummer anhand JOB-List > see 7.1 chapter wählen und eingeben).
- Betriebs- und Schweißart wählen
- Schweißleistung einstellen
- Lichtbogenlänge und Dynamik ggf. korrigieren

5.4.1.1 Basic welding parameters

The user must first determine the basic parameters (material type, wire diameter and shielding gas type) of the welding system. These basic parameters are then compared with the welding job list (JOB-LIST). The combination of the basic parameters gives a JOB number, which must now be entered on the control unit. This basic setting must be rechecked or adjusted only when changing the wire or gas.

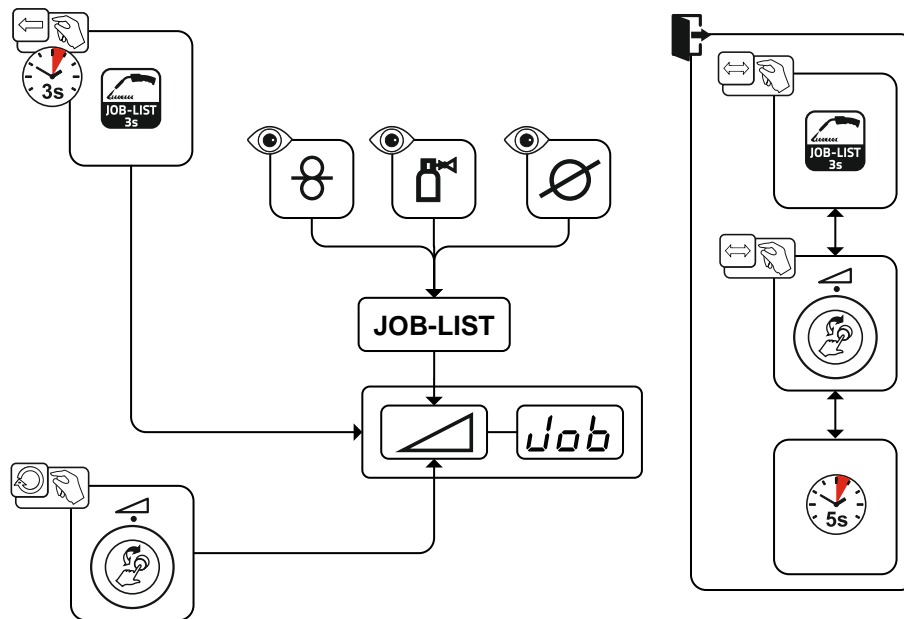

Figure 5-5

5.4.1.2 Welding procedure

After setting the basic parameters you can switch between the welding procedures MIG/MAG, forceArc, wiredArc, rootArc and coldArc (if there is a corresponding combination of the basic parameters). The process change will also change the JOB number, but the basic parameters remain unchanged.

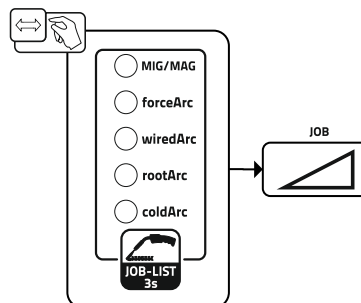

Figure 5-6

5.4.1.3 Operating mode

The operating mode determines the process sequence controlled by the welding torch. Detailed descriptions of the operating modes > see 5.4.4 chapter.

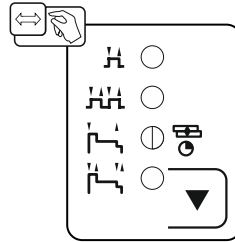

Figure 5-7

5.4.1.4 Welding type

Different forms of MIG/MAG processes are referred to as welding type.

Standard (Welding with standard arc)

Depending on the set combination of wire feed speed and arc voltage, the arc types short arc, transitional arc or spray arc can be used for welding.

Pulse (Welding with pulsed arc)

A targeted change in the welding current generates current pulses in the arc, which lead to a 1 drop per pulse of material transfer. The result is an almost spatter-free process, suitable for welding of all materials, in particular high-alloy CrNi steels or aluminium.

Positionweld (Positional welding)

A combination of the pulse/standard or pulse/pulse welding types, which is particularly suitable for positional welding due to factory-optimized parameters.

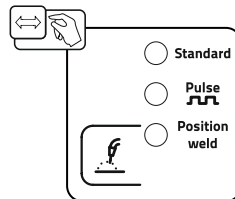

Figure 5-8

5.4.1.5 Welding power (operating point)

The welding power is adjusted according to the principle of one-knob operation. The user can set their operating point optionally as wire feed speed, welding current or material thickness. The optimum welding voltage for the operating point is calculated and set by the welding machine. If necessary, the user can correct this welding voltage > see 5.4.1.7 chapter.

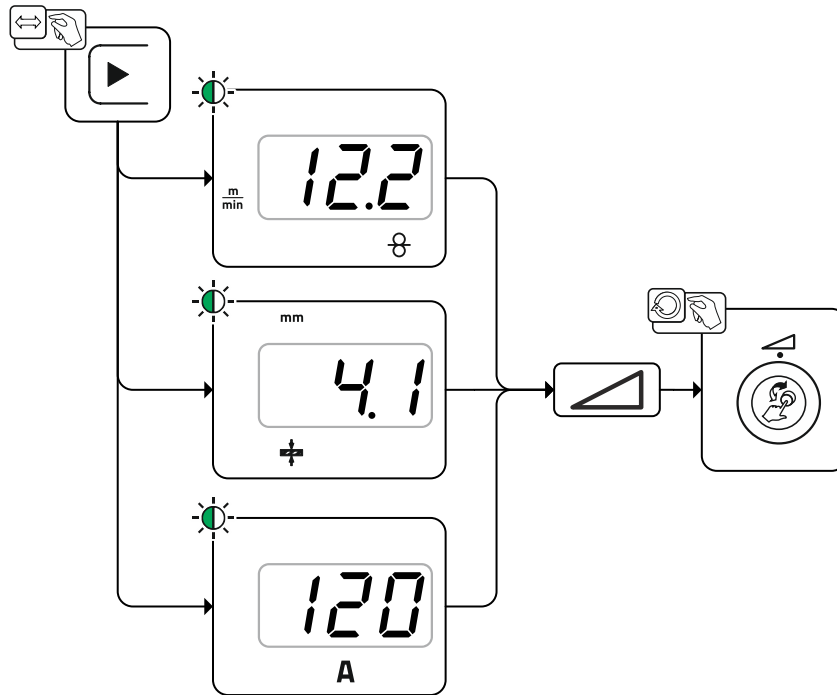

Figure 5-9

Application example (setting via material thickness)

The required wire feed speed is not known and is to be determined.

- Select welding task JOB 76(> see 5.4.1 chapter): material = AlMg, gas = Ar 100%, wire diameter = 1.2 mm.
- Switch the display to material thickness.
- Measure the material thickness (workpiece).
- Set the measured value, e.g. 5 mm, at the machine control.
This set value corresponds to a specific wire feed speed. Switching the display to this parameter will show the associated value.

In this example, a material thickness of 5 mm corresponds to a wire feed speed of 8.4 m/min.

The material thickness details in the welding programs generally refer to fillet welds in the PB welding position. They should be regarded as guideline values and may differ in other welding positions.

5.4.1.6 Accessory components for operating point setting

The operating point can be set at various accessory components as well, such as remote control, special welding torches or robot and industrial bus interfaces (optional interface for automated welding required, not available for all machines of this series).

See the operating instructions for the machine in question for a more detailed description of the individual machines and their functions.

5.4.1.7 Arc length

When required, the arc length (welding voltage) can be adjusted for the welding task in hand by ± 9.9 V.

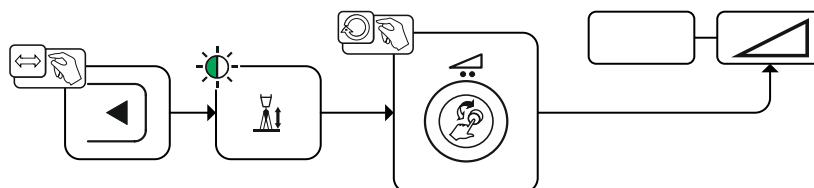

Figure 5-10

5.4.1.8 Arc dynamics (choke effect)

This function can be used to adjust the arc between a narrow, hard arc with deep penetration (positive values) and a wide and soft arc (negative values). In addition, the selected settings are displayed with signal lights below the rotary knobs.

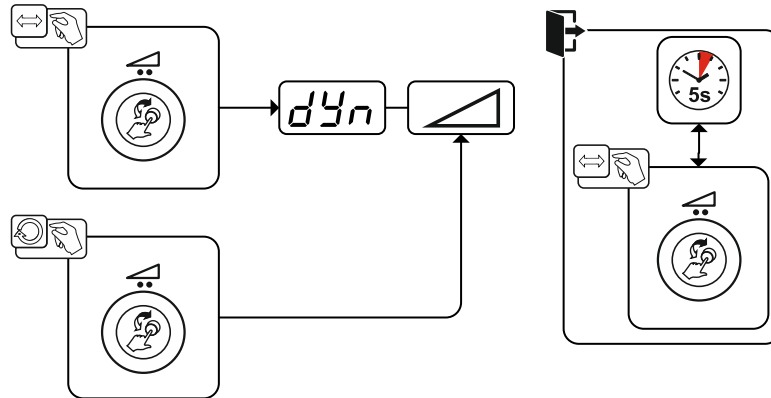

Figure 5-11

5.4.2 Programs (P_A 1-15)

Verschiedene Schweißaufgaben oder Positionen an einem Werkstück benötigen unterschiedliche Schweißprogramme (Arbeitspunkte). In jedem Programm werden folgende Parameter gespeichert:

- Drahtvorschubgeschwindigkeit und Spannungskorrektur (Schweißleistung)
- Betriebsart, Schweißart und Dynamik

5.4.2.1 Selection and adjustment

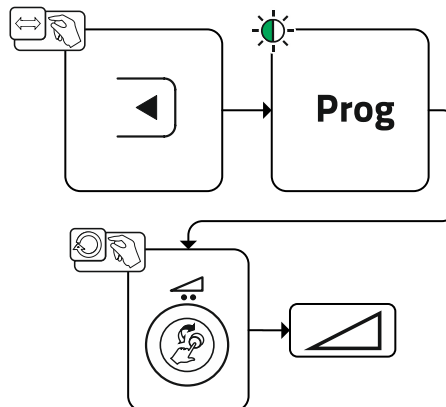

Figure 5-12

The user can change the main program welding parameters using the following components.

	Program switching	JOB switching	Process switching	Welding type	Program	Operating mode	Wire feed speed	Voltage correction	Dynamics
M3.7 – I/J Wire feeder control			✓		P0		✓		
					P1-15				
PC 300.NET Software	✗		✓		P0	✓		✗	
					P1-15		✓		
MT Up/Down Welding torch	✓		✗		P0	✗	✓		✗
					P1-9	✗	✗		
MT 2 Up/Down Welding torch	✓		✗		P0	✗	✓		✗
					P1-15	✗	✗		
MT PC 1 Welding torch	✓		✗		P0	✗	✓		✗
					P1-15	✗	✗		
MT PC 2 Welding torch	✓		✗		P0	✗	✓		✗
					P1-15	✗	✗		
PM 2 Up/Down Welding torch	✓		✗		P0	✗	✓		✗
					P1-15	✗	✗		
PM RD 2 Welding torch	✓		✗		P0	✗	✓		✗
					P1-15	✗	✗		
PM RD 3 Welding torch			✓		P0		✓		
					P1-15				

Example 1: Welding workpieces with different sheet metal thicknesses (non-latched)

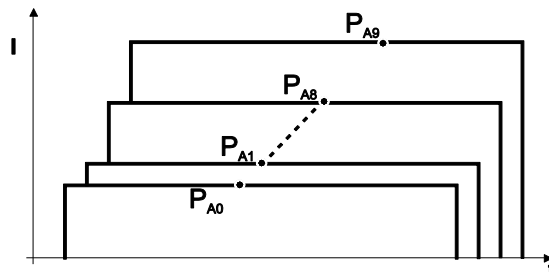

Figure 5-13

Example 2: Welding different positions on a workpiece (latched)

Figure 5-14

Example 3: Aluminium welding of different sheet metal thicknesses (non-latched or latched special)

Figure 5-15

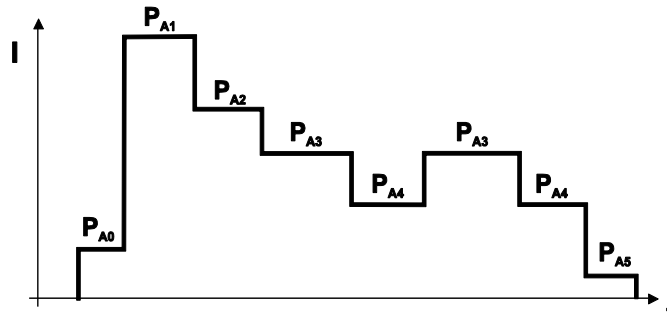

Up to 16 programs (P_{A0} to P_{A15}) can be defined.

An operating point (wire speed, arc length correction, dynamics/choke effect) can be defined permanently in each program.

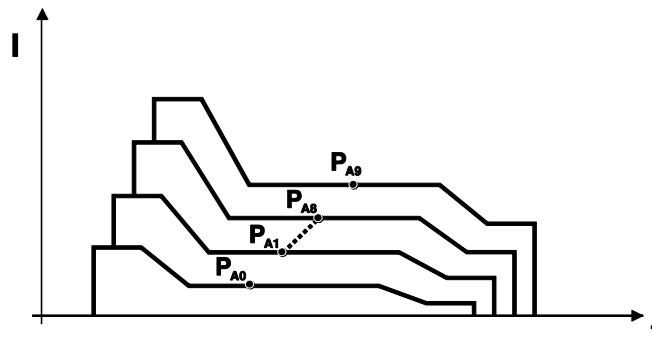
Program P_0 is an exception: the settings for operating points are made manually here.

Changes to the welding parameters are saved immediately!

5.4.3 Program sequence

Certain materials, aluminium for example, require special functions for reliable and high-quality welding. In this case, the special latched mode is used with the following programs:

- Start program P_{START} (avoidance of cold welds at start of seam)
- Main program P_A (constant welding)
- Reduced main program P_B (targeted heat reduction)
- End program P_{END} (avoidance of end-craters by targeted heat reduction)

The programs contain parameters such as wire feed speed (operating point), correction of arc length, slope times, program duration, etc.

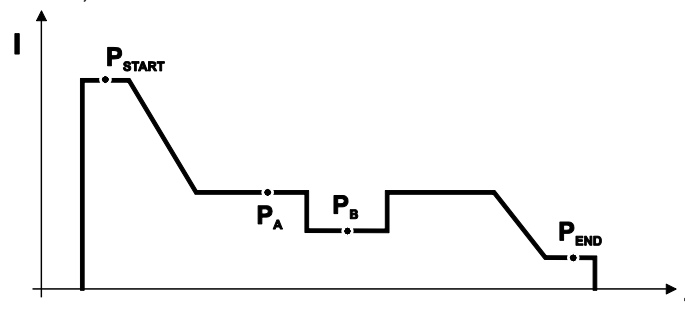

Figure 5-16

5.4.4 Operating modes (functional sequences)

5.4.4.1 Explanation of signs and functions

Symbol	Meaning
	Press torch trigger
	Release torch trigger
	Tap torch trigger (press briefly and release)
	Shielding gas flowing
I	Welding output
	Wire electrode is being conveyed
	Wire creep
	Wire burn-back
	Gas pre-flows
	Gas post-flows
	Non-latched
	Special, non-latched
	Latched
	Special, latched
t	Time
P _{START}	Ignition program
P _A	Main program
P _B	Reduced main program
P _{END}	End program
t ₂	Spot time

5.4.4.2 Automatic cut-out



The welding machine ends the ignition process or the welding process with an

- **ignition fault (no welding current flows within 5 s after the start signal)**
- **arc interruption (arc is interrupted for longer than 5 s)**

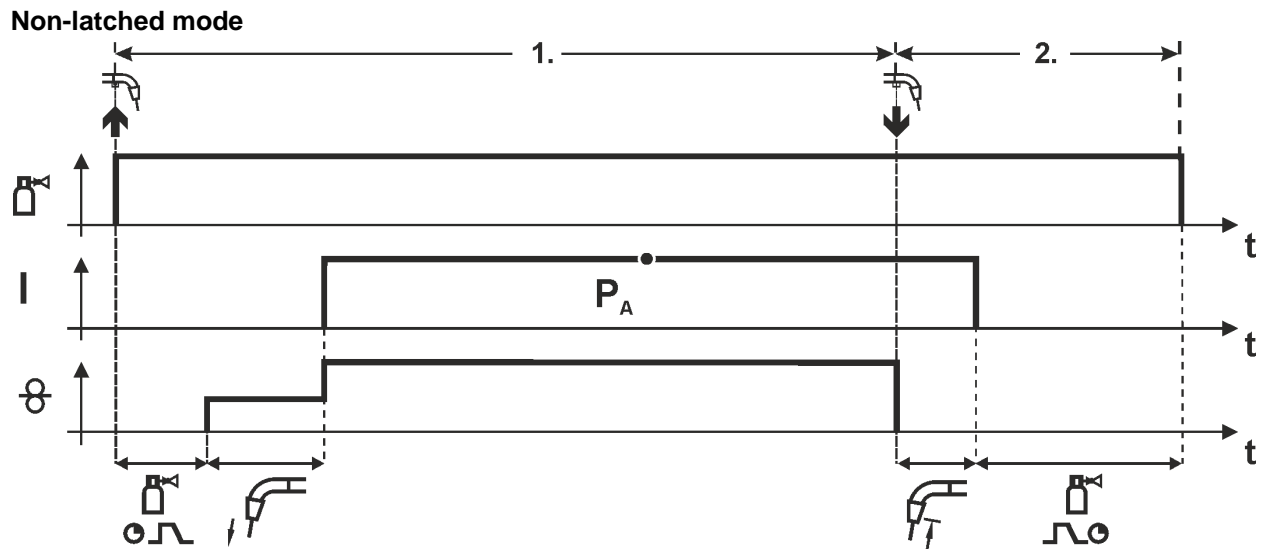

Figure 5-17

Step 1

- Press and hold torch trigger.
- Shielding gas is expelled (gas pre-flows).
- Wire feed motor runs at "creep speed".
- Arc ignites after the wire electrode makes contact with the workpiece; welding current flows.
- Change over to pre-selected wire speed.

Step 2

- Release torch trigger.
- WF motor stops.
- Arc is extinguished after the preselected wire burn-back time expires.
- Gas post-flow time elapses.

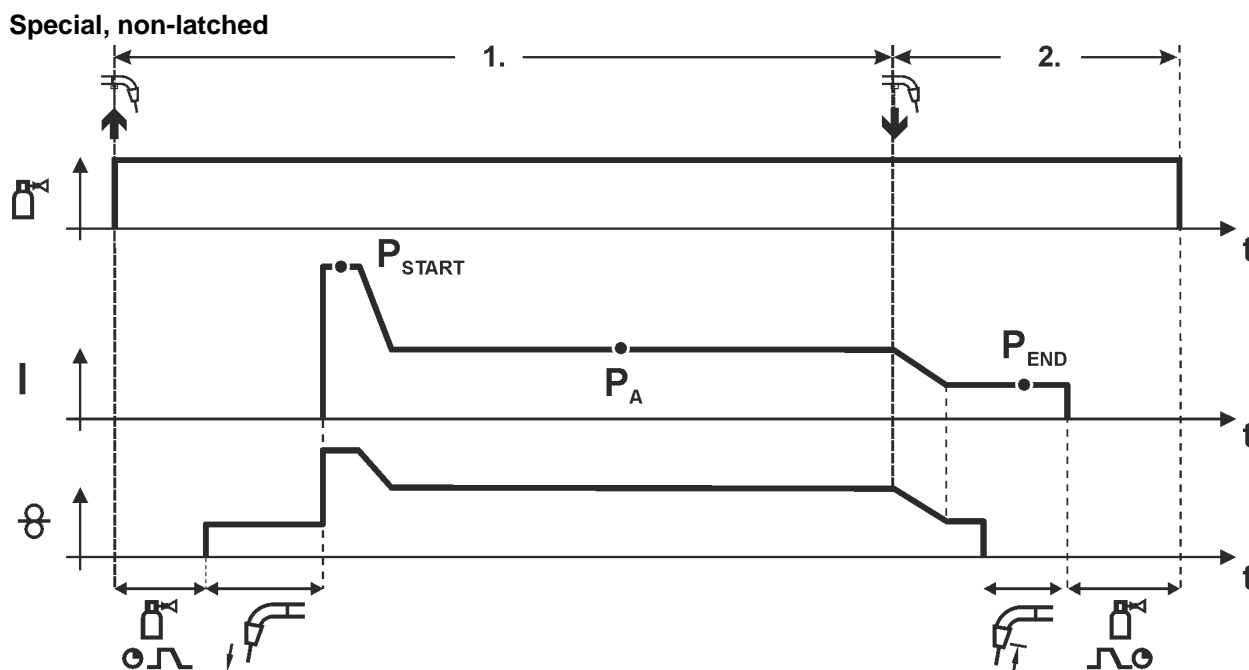

Figure 5-18

Step 1

- Press and hold torch trigger
- Shielding gas is expelled (gas pre-flows)
- Wire feed motor runs at "creep speed".
- Arc ignites after the wire electrode makes contact with the workpiece, welding current is flowing (start program P_{START} for the time t_{start})
- Slope to main program P_A .

Step 2

- Release torch trigger
- Slope to end program P_{END} for the time t_{end} .
- WF motor stops.
- Arc is extinguished after the preselected wire burn-back time expires.
- Gas post-flow time elapses.

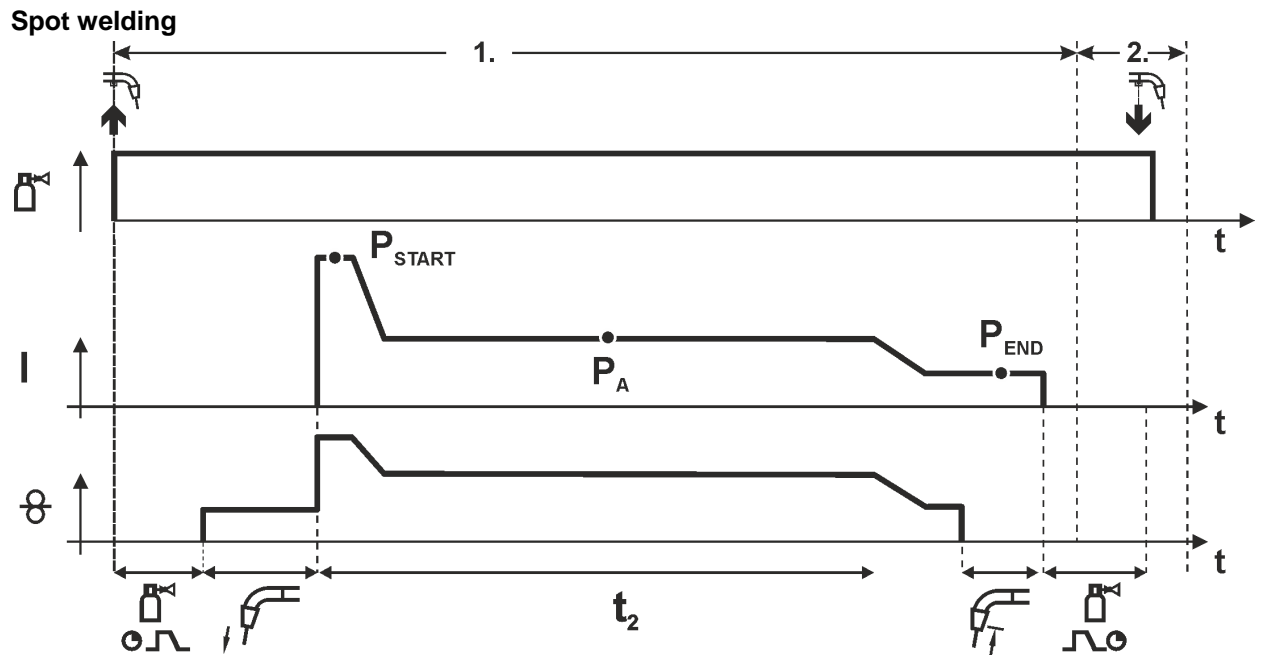

Figure 5-19

The ignition time t_{start} must be added to the spot time t_2 .

1st cycle

- Press and hold torch trigger
- Shielding gas is expelled (gas pre-flows)
- Wire feed motor runs at "creep speed"
- Arc ignites after the wire electrode makes contact with the workpiece, welding current is flowing (start program P_{START} , spot time starts)
- Slope to main program P_A
- After the set spot time elapses, slope goes to end program P_{END} .
- Wire feed motor stop welding.
- Arc is extinguished after the pre-selected wire burn-back time elapses
- Gas post-flow time elapses.

2nd cycle

- Release torch trigger

Releasing the torch trigger (step 2) interrupts the welding process even if the spot time has not yet elapsed (slope to end program P_{END}).

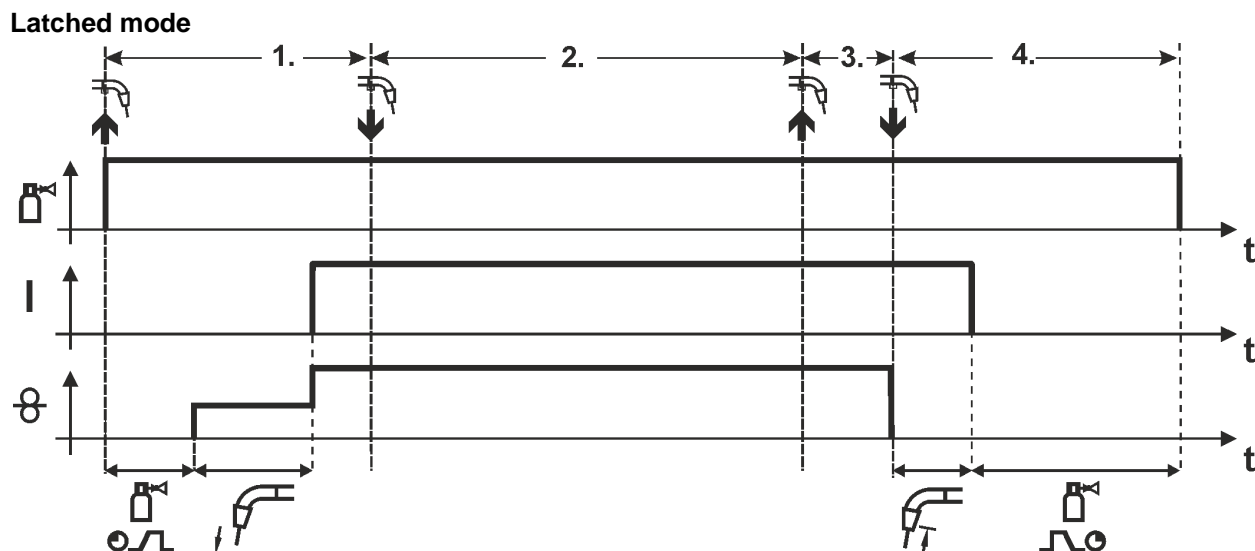

Figure 5-20

Step 1

- Press and hold torch trigger
- Shielding gas is expelled (gas pre-flows)
- Wire feed motor runs at “creep speed”.
- Arc ignites after the wire electrode makes contact with the workpiece; welding current flows.
- Change over to pre-selected WF speed (main program P_A).

Step 2

- Release torch trigger (no effect)

Step 3

- Press torch trigger (no effect)

Step 4

- Release torch trigger
- WF motor stops.
- Arc is extinguished after the preselected wire burn-back time expires.
- Gas post-flow time elapses.

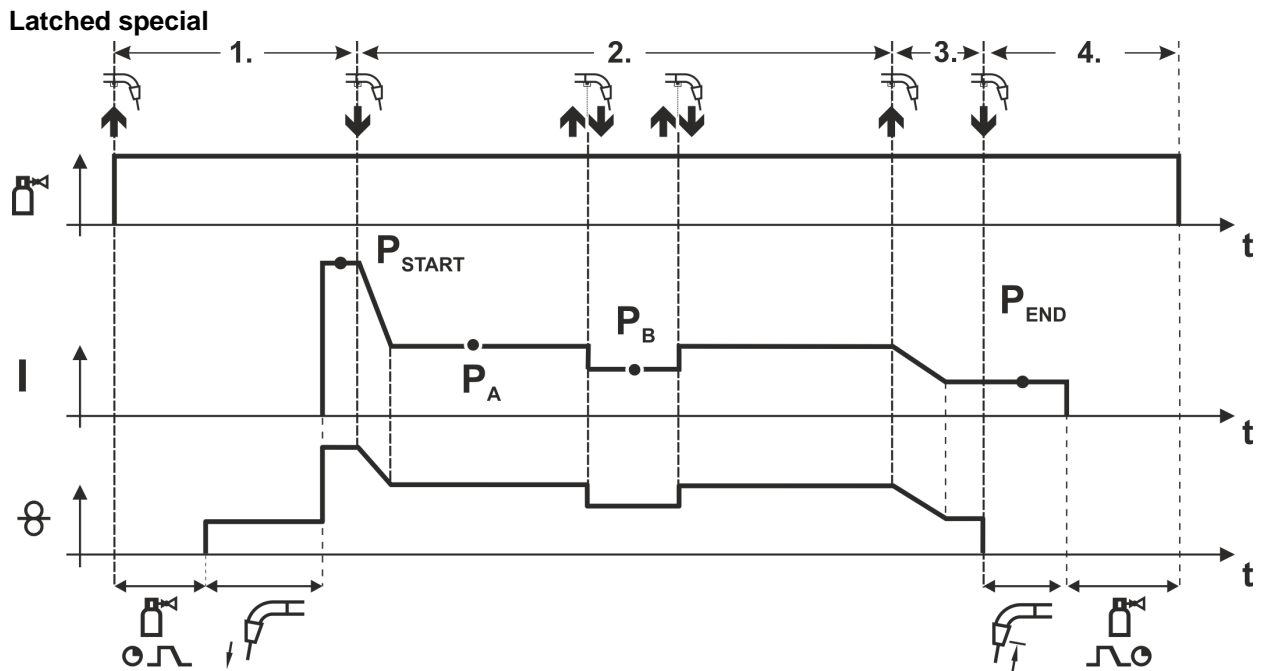

Figure 5-21

Step 1

- Press and hold torch trigger
- Shielding gas is expelled (gas pre-flows)
- Wire feed motor runs at "creep speed".
- Arc ignites after the wire electrode makes contact with the workpiece, welding current is flowing (start program P_{START})

Step 2

- Release torch trigger
- Slope to main program P_A .

The slope on main program P_A is given at the earliest after the set time t_{START} elapses and at the latest when the torch trigger is released.

Tapping¹⁾ can be used to change over to the reduced main program P_B .

Repeated tapping will switch back to the main program P_A .

Step 3

- Press and hold torch trigger
- Slope to end program P_{END} .

Step 4

- Release torch trigger
- WF motor stops.
- Arc is extinguished after the preselected wire burn-back time expires.
- Gas post-flow time elapses.



¹⁾ Prevent tapping (brief press and release within 0.3 seconds)

If the welding current is to be prevented from switching over to the reduced main program P_B by tapping, the parameter value for WF3 needs to be set to 100% ($P_A = P_B$) in the program sequence.

Special latched with changing welding method by tapping (process switching)

To activate or set the function .

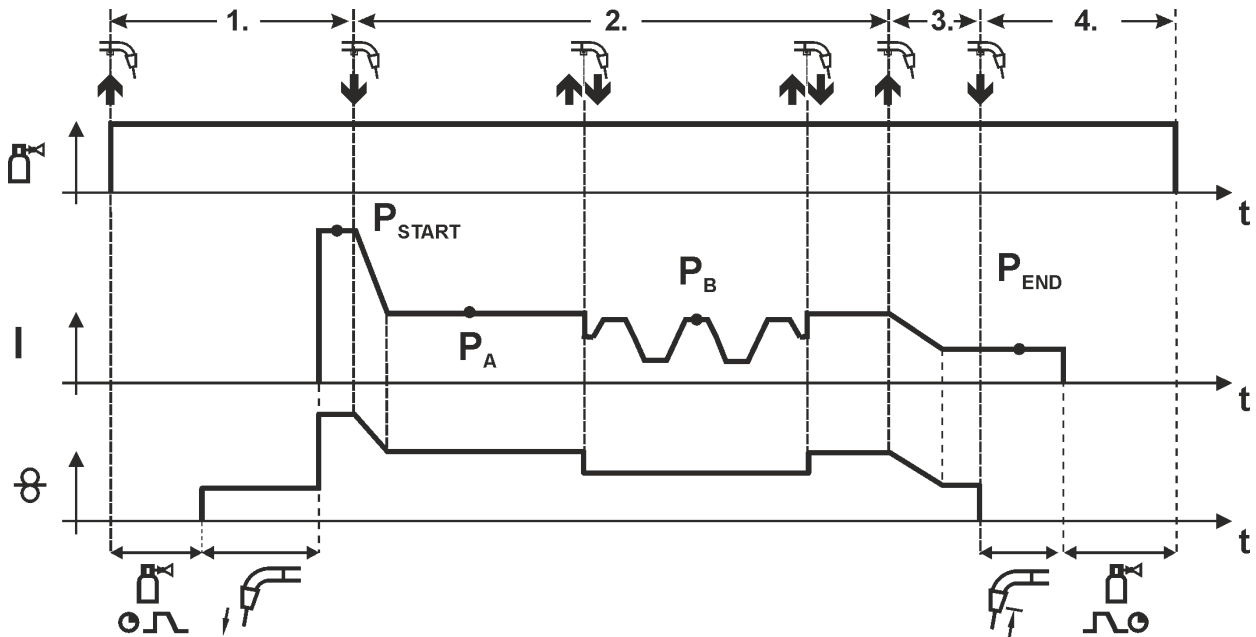

Figure 5-22

1st cycle

- Press and hold torch trigger.
- Shielding gas is expelled (gas pre-flows)
- Wire feed motor runs at "creep speed"
- Arc ignites after the wire electrode makes contact with the workpiece, welding current is flowing (start program P_{START})

2nd cycle

- Release torch trigger
- Slope on main program P_A

The slope on main program P_A is given at the earliest after the set time t_{START} elapses and at the latest when the torch trigger is released.

Tapping (pressing the torch trigger for less than 0.3 sec.) changes over the welding process (P_B).

If a standard process has been defined in the main program, tapping changes to the pulse process, and tapping again will return to the standard process, etc.

3rd cycle

- Press and hold torch trigger
- Slope to end program P_{END}

4th cycle

- Release torch trigger
- WF motor stops
- Arc is extinguished after the pre-selected wire burn-back time elapses
- Gas post-flow time elapses

This function can be activated using the PC300.NET software.
Refer to the software operating instructions.

5.4.5 forceArc / forceArc puls

Heat-reduced, directionally-stable and powerful arc with deep fusion penetration for the upper power range.

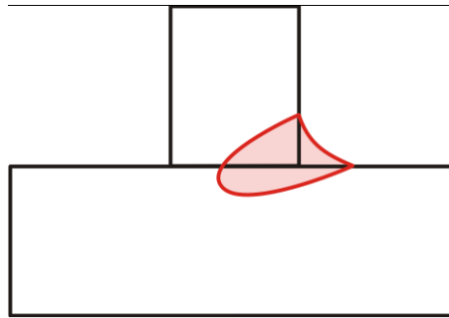

Figure 5-23

- Smaller included angle due to deep penetration and directionally stable arc
- Excellent root and sidewall fusion
- Secure welding also with very long stick-outs
- Reduced undercuts
- Manual and automated applications

You can make use of these properties after selecting the forceArc process > see 5.4.1 chapter.

As with pulse arc welding, it is important to make sure of a good welding current connection.

- Keep welding current cables as short as possible and ensure that cable cross-sections are adequate!
- Fully unroll welding current cables, torch hose packages and, if applicable, intermediate hose packages. Avoid loops!
- Use welding torches, preferably water-cooled, that are suitable for the higher power range.
- Use welding wire with adequate copper coating when welding steel. The wire spool should have layer spooling.



Unstable arc!

Welding current cables that are not fully unrolled can cause faults in the arc (flickering).

- **Fully unroll welding current cables, torch hose packages and, if applicable, intermediate hose packages. Avoid loops!**

5.4.6 wiredArc

Welding process with active wire control for stable and uniform penetration characteristics and perfect arc length stability, even in difficult applications and positional welding.

With a GMAW arc, the welding current (AMP) changes with the change of the stick-out. If, for instance, the stick-out is extended, the welding current decreases at constant wire feed speed (DG). Thus, the heat input into the workpiece (molten metal) decreases and the penetration reduces.

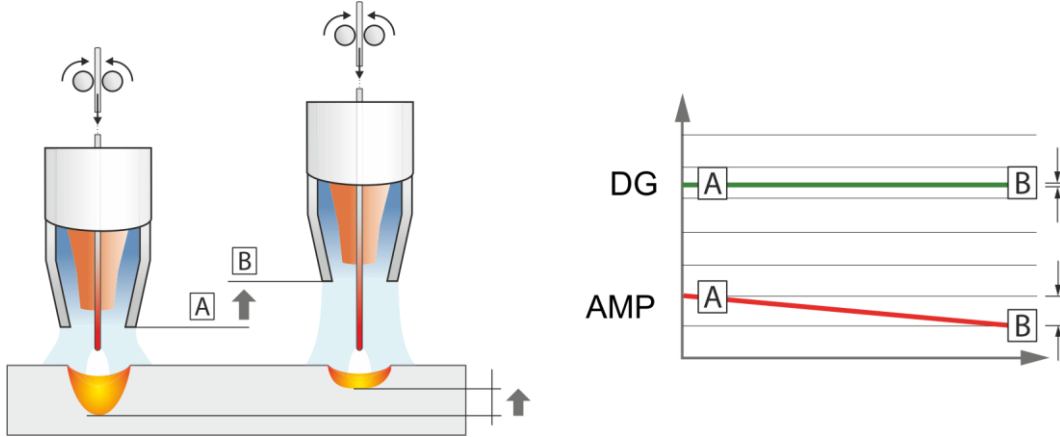

Figure 5-24

With the EWM wiredArc arc with wire control, the welding current (AMP) changes with the change of the stick-out only slightly. The compensation of the welding current takes place with an active control of wire feed speed (DG). If, for instance, the stick-out is extended, the wire feed speed will be increased. Due to this, the welding current remains almost constant and thus the heat input into the workpiece remains almost constant. As a result, the penetration changes with the change of the stick-out only slightly.

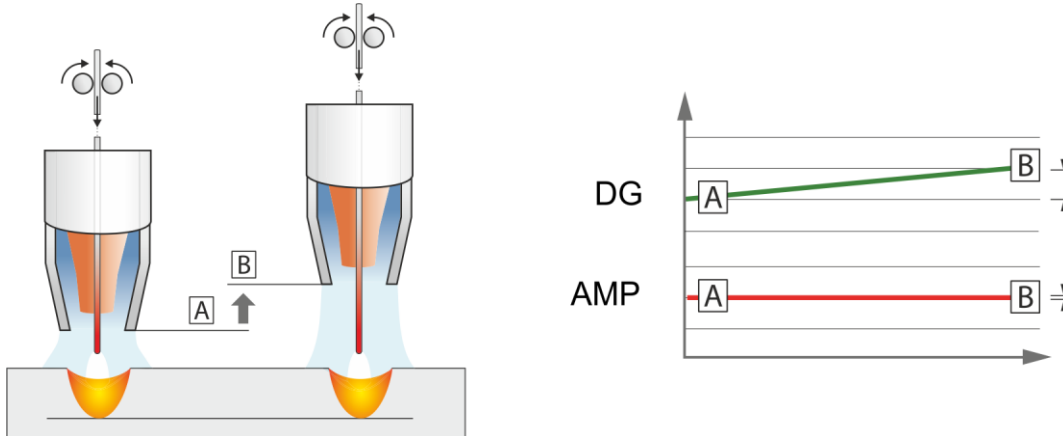

Figure 5-25

5.4.7 rootArc/rootArc puls

Short arc with perfect weld modelling capabilities for effortless gap bridging, especially for root welding

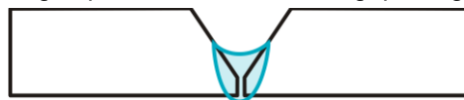

Figure 5-26

- Reduced spatter compared to standard short arc
- Good root formation and secure sidewall fusion
- Manual and automated applications



Unstable arc!

Welding current cables that are not fully unrolled can cause faults in the arc (flickering).

- **Fully unroll welding current cables, torch hose packages and, if applicable, intermediate hose packages. Avoid loops!**

5.4.8 coldArc / coldArc puls

Heat-reduced, low-spatter short arc for high dimensional stability welding and brazing of thin metal sheets with excellent gap-bridging.



Figure 5-27

After selecting the coldArc process > see 5.4.1 chapter you benefit from:

- Less distortion and reduced discolouration thanks to minimised heat input
- Considerably reduced spatter thanks to virtually power-free material transfer
- Easy welding of the root passes in all plate thicknesses and in all positions
- Perfect gap bridging even with inconsistent gap widths
- Manual and automated applications

You can make use of these properties after selecting the coldArc process (see the "Selecting a MIG/MAG welding task" chapter).

With coldArc welding, it is important to ensure good quality wire feeding because of the welding filler materials being used!

- Equip the welding torch and torch hose package to suit the task! (and the operating instructions for the welding torch.)



This function can only be enabled with the PC300.NET software.
(See operating instructions for the software)

5.4.9 Standard MIG/MAG torch

The MIG welding torch trigger is essentially used to start and stop the welding process.

Operating elements	Functions
 Torch trigger	<ul style="list-style-type: none"> • Start/stop welding

Other functions are also possible by tapping the torch trigger, depending on the machine type and control configuration > see 5.10 chapter:

- Change over between welding programs (P8).
- Program selection before starting welding (P17).
- Change over between pulse and standard welding in the special latched operating mode.
- Switching between wire feed units in dual operation mode (P10).

5.4.10 MIG/MAG special-torches

Function specifications and more indepth information can be found in the operating manual for the relevant welding torch!

5.4.10.1 Program and up/down operation

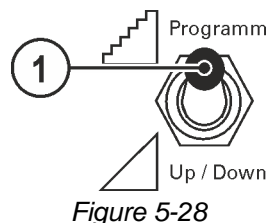





Figure 5-28

Item	Symbol	Description
1		<p>Welding torch function changeover switch (special welding torch required)</p> <p> Changing over programs or JOBs</p> <p> Infinite adjustment of welding performance.</p>

5.4.10.2 Switching between Push/Pull and intermediate drive

⚠ WARNING



Do not carry out any unauthorised repairs or modifications!
To avoid injury and equipment damage, the unit must only be repaired or modified by specialist, skilled persons!
The warranty becomes null and void in the event of unauthorised interference.

- Appoint only skilled persons for repair work (trained service personnel)!

Before reconnection, “Inspection and Testing during Operation” according to IEC/BS EN 60974-4 “Arc welding systems – Inspection and Testing during Operation” has to be performed!

The plugs are located directly on the M3.7X printed circuit board.

Plug	Function
on X24	Operation with Push/Pull welding torch (factory setting)
on X23	Operation with intermediate drive

5.5 TIG welding

5.5.1 Welding task selection

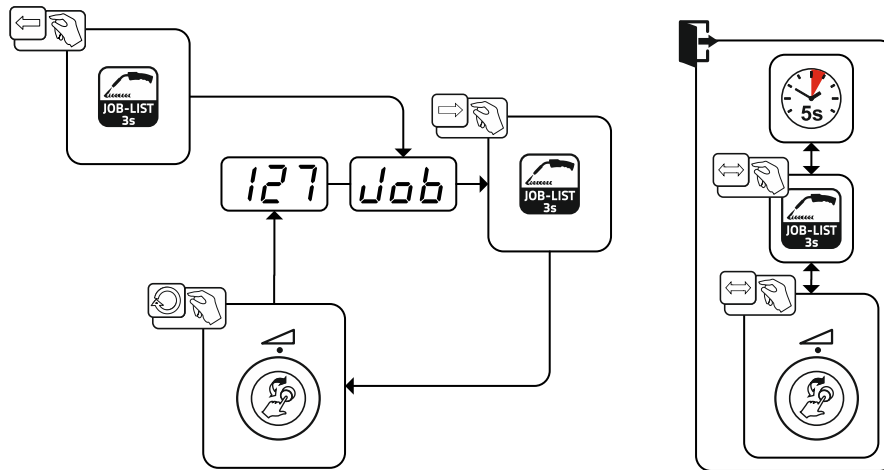

Figure 5-29

5.5.1.1 Welding current setting

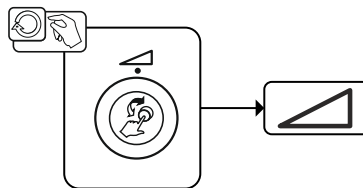

Figure 5-30

5.5.2 TIG arc ignition

5.5.2.1 Liftarc

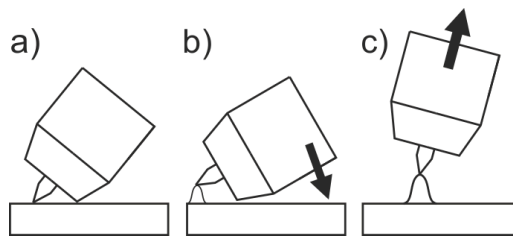

Figure 5-31











The arc is ignited on contact with the workpiece:

- Carefully place the torch gas nozzle and tungsten electrode tip onto the workpiece and press the torch trigger (liftarc current flowing, regardless of the main current set).
- Incline the torch over the torch gas nozzle to produce a gap of approx. 2-3 mm between the electrode tip and the workpiece. The arc ignites and the welding current is increased, depending on the operating mode set, to the ignition or main current set.
- Lift off the torch and swivel to the normal position.

Ending the welding process: Release or press the torch trigger depending on the operating mode selected.

5.5.3 Operating modes (functional sequences)

5.5.3.1 Explanation of signs and functions

Symbol	Meaning
	Press torch trigger
	Release torch trigger
	Tap torch trigger (press briefly and release)
	Shielding gas flowing
I	Welding output
	Gas pre-flows
	Gas post-flows
	Non-latched
	Special, non-latched
	Latched
	Special, latched
t	Time
P _{START}	Ignition program
P _A	Main program
P _B	Reduced main program
P _{END}	End program
tS1	Slope duration from P _{START} to P _A

5.5.3.2 Automatic cut-out



The welding machine ends the ignition process or the welding process with an

- **ignition fault (no welding current flows within 5 s after the start signal)**
- **arc interruption (arc is interrupted for longer than 5 s)**

Non-latched mode

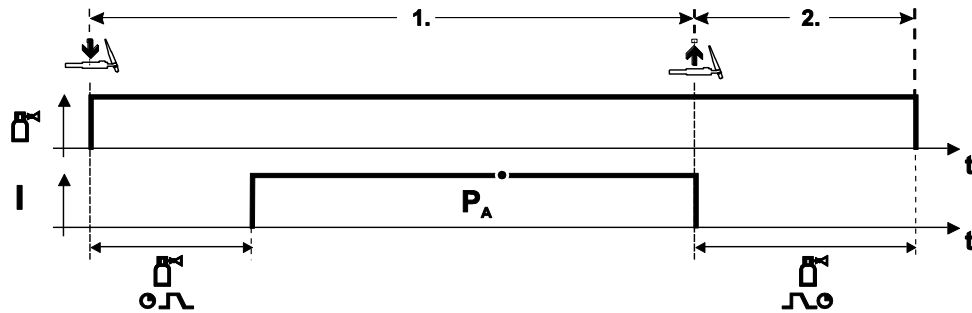

Figure 5-32

Selection

- Select non-latched operating mode

Step 1

- Press and hold torch trigger.
- Shielding gas is expelled (gas pre-flows).

The arc is ignited using liftarc.

- Welding current flows with pre-selected setting.

Step 2

- Release torch trigger.
- Arc is extinguished.
- Gas post-flow time elapses.

Special, non-latched

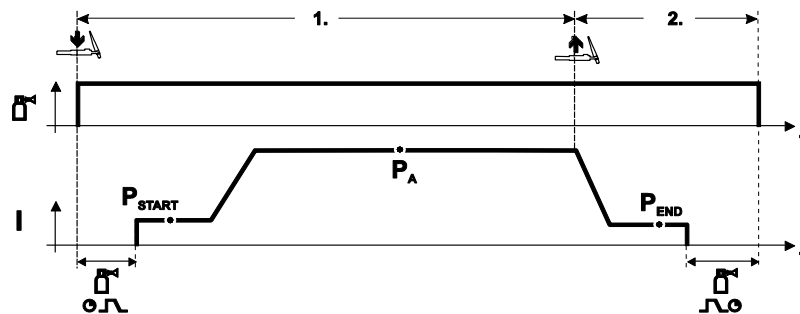

Figure 5-33

Selection

- Select non-latched special mode

Step 1

- Press and hold torch trigger
- Shielding gas is expelled (gas pre-flows)

The arc is ignited using liftarc.

- Welding gas flows with pre-selected setting in start program "P_{START}".
- After the "t_{start}" ignition current time elapses, the welding current rises with the set upslope time "t_{S1}" to the main program "P_A".

Step 2

- Release torch trigger.
- The welding current reduces with the downslope time "t_{Se}" to the end program "P_{END}".
- After the end current time "end" elapses, the arc will extinguish.
- Gas post-flow time elapses.

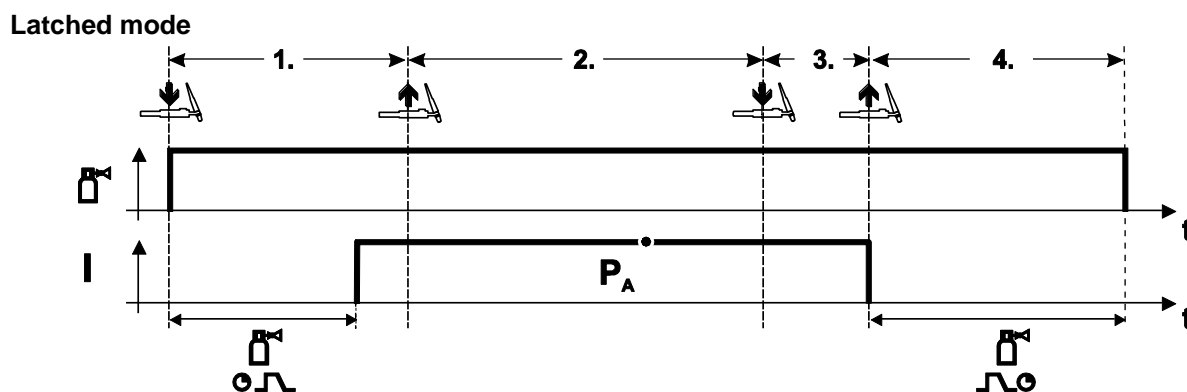

Figure 5-34

Selection

- Select latched operating mode

Step 1

- Press and hold torch trigger
- Shielding gas is expelled (gas pre-flows)

The arc is ignited using liftarc.

- Welding current flows with pre-selected setting.

Step 2

- Release torch trigger (no effect)

Step 3

- Press torch trigger (no effect)

Step 4

- Release torch trigger
- Arc is extinguished.
- Gas post-flow time elapses.

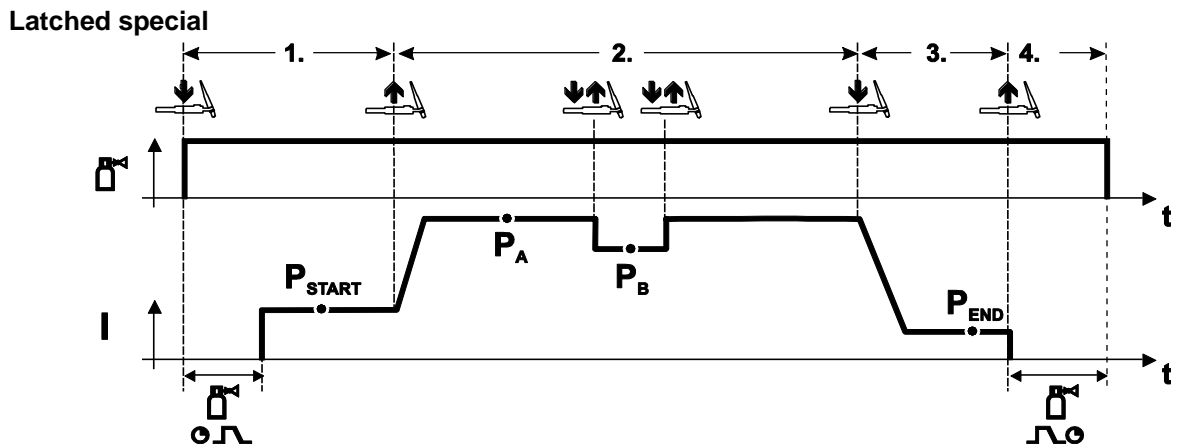

Figure 5-35

Selection

- Select latched special mode

Step 1

- Press and hold torch trigger.
- Shielding gas is expelled (gas pre-flows).

The arc is ignited using liftarc.

- Welding gas flows at pre-selected setting in start program "P_{START}".

Step 2

- Release torch trigger.
- Slope on main program "P_A".

The slope on main program P_A is given at the earliest after the set time t_{START} elapses and at the latest when the torch trigger is released.

Tapping can be used to switch to the reduced main program "P_B". Repeated tapping will switch back to the main program "P_A".

Step 3

- Press the torch trigger.
- Slope to end program "P_{END}".

Step 4

- Release torch trigger.
- Arc is extinguished.
- Gas post-flow time elapses.

5.6 MMA welding

5.6.1 Welding task selection

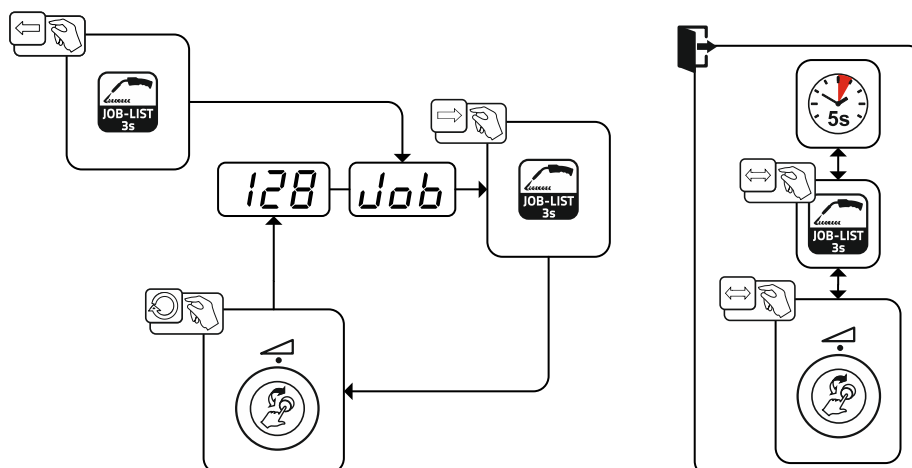

Figure 5-36

5.6.1.1 Welding current setting

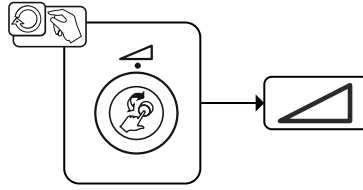

Figure 5-37

5.6.2 Arcforce

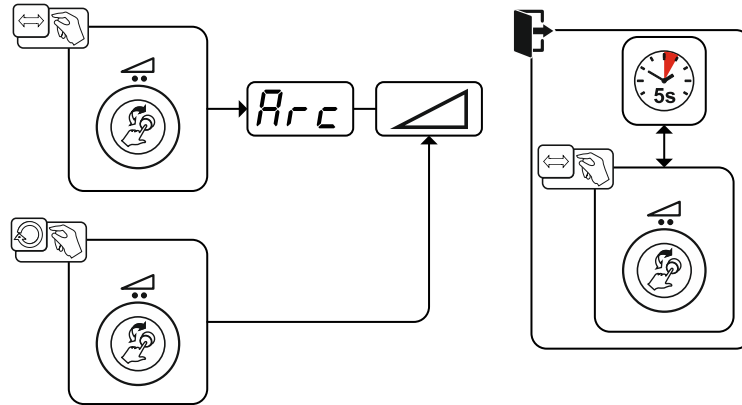

Figure 5-38

Setting:

- Negative values: rutile electrode types
- Values at zero: basic electrode types
- Positive values: cellulose electrode types

5.6.3 Hotstart

The function hot start ensures a secure igniting of the arc and a sufficient heating to the still cold parent metal at the beginning of the welding process. The ignition takes place here with increased current (hot start current) over a certain time (hot start time).

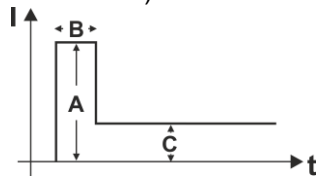

A = Hot start current
 B = Hot start time
 C = Main current
 I = Current
 t = Time

Figure 5-39

5.6.4 Antistick

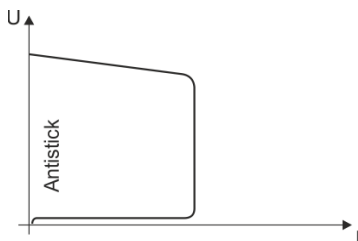

The Antistick feature prevents the electrode from annealing.

Should the electrode stick despite the Arcforce feature, the machine automatically switches to the minimum current within approx. one second. This prevents the electrode from annealing. Check the welding current setting and correct for the welding task in hand.

Figure 5-40

5.7 Options (additional components)

5.7.1 Electronic gas flow control (OW DGC)

The connected gas line has to have a preset pressure of 3–5 bar.

The electronic gas flow control (DGC) regulates the optimum gas flow rate for the respective welding process (optimally preset from the factory). This helps avoid welding errors caused by too much (gas blast) or insufficient shielding gas (shielding gas cylinder empty or gas supply interrupted).

The required gas flow rate can be controlled by the user and corrected if necessary (nominal values before welding). In addition, when used in combination with Xnet software (optional), the exact gas consumption can be recorded.

The parameter is selected by pressing the parameter display push-button on the right side. The signal light "D" is illuminated. The value units can be in litres per minute "l/min" or Cubic Feet Per Hour "cFH" (adjustable with special parameters P29 > see 5.10 chapter). During the welding process, these nominal values are compared with the actual values. If these values differ more than the specified error threshold (special parameters P28) the error message "Err 8" is output and the continuous welding process is stopped.

5.7.2 Wire reserve sensor (OW WRS)

Minimizes the risk of seam errors due to early detection and display (signal light "End") with about 10 % remaining wire. At the same time, the forward-looking production allows the reduction of the auxiliary process times.

5.7.3 Wire spool heater (OW WHS)

Prevention of condensation on the welding wire due to adjustable temperature (special parameters P26 > see 5.10 chapter) of the wire spool heater.

5.8 Access control

To prevent people from unauthorised or inadvertent changing of the welding parameters at the machine, entering values on the control can be blocked by using the key switch.

With the key switch in position , all functions and parameters can be configured without any restriction.

In the key position  the following functions or parameters can not be changed:

- No adjustment of the operating point (welding performance) in programs 1–15.
- No change of welding or operating mode in programs 1–15.
- No welding task switching (JOB block operation P16 possible).
- No change of special parameters (except P10). Restart required.

5.9 Voltage reducing device

Only machine variants with the (VRD/AUS/RU) code are equipped with a voltage reduction device (VRD). The VRD is used for increased safety, especially in hazardous environments such as shipbuilding, pipe construction or mining.

A VRD is mandatory in some countries and required by many on-site safety instructions for power sources.

The VRD > see 4 chapter signal light is illuminated when the voltage reduction device is operating without fault and the output voltage is reduced to a value specified in the relevant standard (see technical data).

5.10 Special parameters (advanced settings)

Special parameters (P1 to Pn) are applied for customer-specific configuration of machine functions. This allows the user maximum flexibility in optimising their requirements.

These settings are not configured directly on the machine control since a regular setting of the parameters is generally not required. The number of selectable special parameters can deviate between the machine controls used in the welding system (also see the relevant standard operating instructions).

If required, the special parameters can be reset to the factory settings > see 5.10.2 chapter.

5.10.1 Selecting, changing and saving parameters

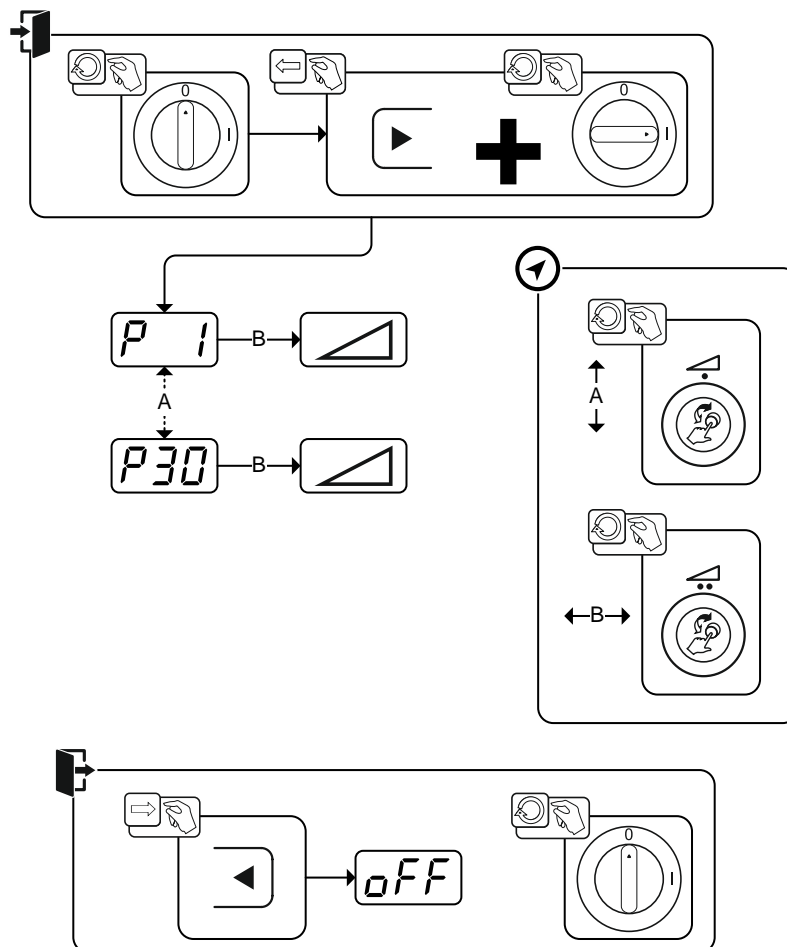

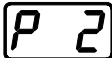
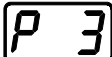
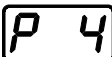
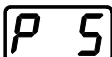
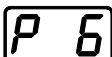
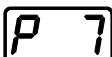

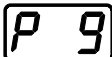

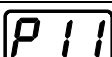
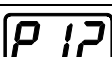
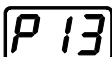
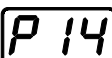



Figure 5-41

Display	Setting/selection
	Wire inching / wire return ramp time 0 =-----normal inching (10 s ramp time) 1 =-----fast inching (3 s ramp time) (ex works)
	Block program "0" 0 =-----P0 enabled (Ex works) 1 =-----P0 blocked
	Display mode for Up/Down welding torch with one-digit 7-segment display (two keys) 0 =-----normal display (ex works) program number/welding power (0–9) 1 =-----display toggles between program number/welding type
	Program limitation Programs 1 to max. 15 Ex works: 15
	Special cycle in the special latched and non-latched operating modes 0 =-----normal (previous) non-latched/latched (Ex works) 1 =-----WF3 cycle for non-latched/latched
	Enable special jobs SP1 to SP3 0 =-----no enabling (Ex works) 1 =-----enabling of Sp1-3
	Correction operation, threshold value setting 0 =-----correction operation switched off (Ex works) 1 =-----correction operation on "Main program (PA)" flashing
	Program changeover with standard torch 0 =-----no program changeover (Ex works) 1 =-----special latched 2 =-----specific latched special (n cycle active)
	Tapping start for latched and special latched operation 0 =-----no 4-cycle inching start 1 =-----4-cycle inching start possible (ex works)
	One or two-wire feed operation 0 =-----single operation (Ex works) 1 =-----dual operation, this unit is the "master" 2 =-----dual operation, this unit is the "slave"
	Special latched tapping time 0 = tapping function switched off 1 = 300ms (Ex works) 2 = 600ms
	JOB list changeover 0 =-----task-oriented JOB list 1 =-----actual JOB list (Ex works) 2 =-----actual JOB list, JOB changeover activated via accessories
	Lower limit remote JOB switching JOB range of the function torches (MT PC2, PM 2U/D, PM RD2) Lower limit: 129 (ex works)
	Upper limit remote JOB switching JOB-Barea of the functional torch (MT PC2, PM 2U/D, PM RD2) Upper limit: 169 (ex works)
	HOLD function 0 =-----HOLD values are not displayed 1 =-----HOLD values are displayed (Ex works)

Display	Setting/selection
P16	Block JOB mode 0 = ----- Block JOB mode not enabled (Ex works) 1 = ----- Block JOB mode enabled
P17	Program selection with standard torch trigger 0 = ----- no program selection (Ex works) 1 = ----- program selection possible
P19	Mean value display for superPuls 0 = ----- Function switched off. 1 = ----- Function switched on (ex factory).
P20	Predefined pulse arc welding process in the PA program 0 = ----- Predefined pulse arc welding process in the PA program is disabled. 1 = ----- If the superPuls and welding process switching functions are available and activated, the pulse arc welding process is always executed in the main program PA (ex factory).
P21	Predefined absolute value for relative programs Start program (P_{START}), down-slope program (P_B) and end program (P_{END}) can be set relative to the main program (P_A) or in an absolute manner, as desired. 0 = ----- Relative parameter setting (ex factory) 1 = ----- Absolute parameter setting
P22	Electronic gas flow control, type 1 = ----- type A (ex works) 0 = ----- type B
P23	Program settings for relative programs 0 = ----- Combined setting of relative programs possible (ex works). 1 = ----- Individual setting of relative programs possible (ex works).
P24	Correction or nominal voltage display 0 = ----- Correction voltage display (ex works). 1 = ----- Absolute nominal voltage display.
P25	JOB-Selection with Expert operating mode > see 5.10.1.22 chapter 0 = ----- SP1-SP3 Switching on the wire feeder if the machine has an expert control (ex works) 1 = ----- JOB selection of wire feeder possible
P26	Nominal value of wire spool heater (OW WHS) > see 5.10.1.23 chapter off = switched off Temperature setting range: 25°C - 50°C (45°C ex works)
P27	Operating mode switching at welding start > see 5.10.1.24 chapter 0 = ----- Not enabled (ex works) 1 = ----- Enabled
P28	Error threshold of electronic gas flow control > see 5.10.1.25 chapter Error output in case of gas nominal value deviation
P29	Unit system > see 5.10.1.26 chapter 0 = ----- metric system (ex works) 1 = ----- Imperial system
P30	Selection option for program sequence with rotary knob > see 5.10.1.27 chapter 0 = ----- Not enabled 1 = ----- Enabled (ex works)

5.10.1.1 Ramp time for wire inching (P1)

The wire inching starts with a speed 1.0 m/min for 2 secs. It is subsequently increased to a ramp function to 6.0 m/min. The ramp time can be set between two ranges.

During wire inching, the speed can be changed by means of the welding power rotary knob. Changing the speed has no effect on the ramp time.

5.10.1.2 Program "0", releasing the program block (P2)

The program P0 (manual setting) is blocked. Only operation with P1-P15 is possible, irrespective of the key switch position.

5.10.1.3 Display mode for Up/Down welding torch with one-digit 7-segment display (P3)

Normal display:

- Program mode: Program number
- Up/down operation: Welding power (0=minimum current/9=maximum current)

Toggle display:

- Program mode: Program number and welding procedure (P=pulse/n=not pulse) are toggled
- Up/down operation: Welding power (0=minimum current/9=maximum current) and symbol for up/down operation are toggled

5.10.1.4 Program limit (P4)

Program selection can be limited with the special parameter P4.

- The setting is adopted for all JOBS.
- Program selection depends on the position of the "welding torch function" changeover switch ().

Programs can only be switched when the changeover switch is in the "program" position.

- Programs can be switched by means of a connected remote control or special welding torch.
- If a special welding torch or a remote control is not connected, it is only possible to switch programs by means of the "arc length correction/select welding program" rotary dial ().

5.10.1.5 Special cycle in the operating modes special latched and non-latched (P5)

With the special sequence activated, the start of the welding process changes as follows:

Sequence for special non-latched mode/special latched mode:

- Start program "P_{START}"
- Main program "P_A"

Sequence for special non-latched mode/special latched mode with custom sequence activated:

- Start program "P_{START}"
- Reduced main program "P_B"
- Main program "P_A"

5.10.1.6 Correction operation, threshold value setting (P7)

The correction operation is switched on and off for all JOBS and their programs at the same time. A correction operation is specified for wire speed (DV) and welding voltage correction (U_{kor}) for each JOB. The correction value is saved separately for each program. The correction range can be maximum 30% of the wire speed and +/-9.9 V welding voltage.

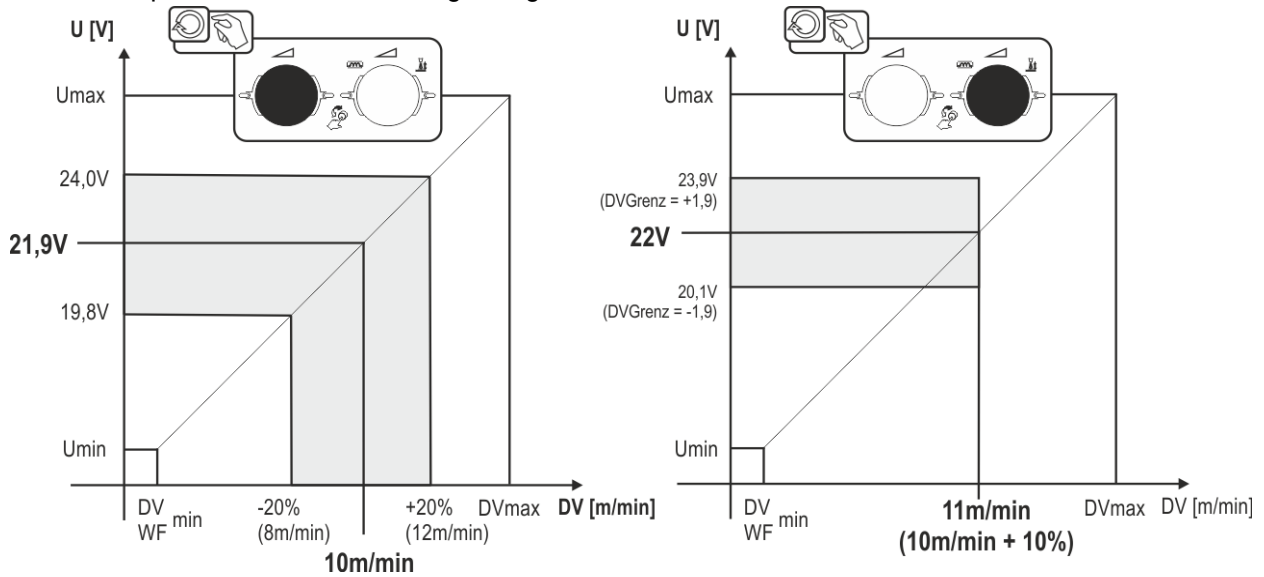

Figure 5-42

Example for the operating point in correction mode:

The wire speed in one program (1 to 15) is set on 10.0 m/min.

This corresponds to a welding voltage (U) of 21,9 V. When the key switch is set to "0" position, welding in this program can only be carried out with these values.

To allow the welder also to perform wire and voltage correction in program mode, the correction mode must be switched on and limit values for wire and voltage must be specified.

Setting of the correction limit value = WFLimit = 20% / Ulimit = 1.9 V

Now the wire speed can be corrected by 20% (8.0 up to 12.0 m/min) and the welding voltage by +/-1.9 V (3.8 V).

In the example the wire speed is set on 11.0 m/min. This corresponds to a welding voltage of 22 V

Now the welding voltage can be corrected by further 1.9 V (20.1 V and 23.9 V).

The values for voltage and wire-speed correction will be reset if the key switch is moved to the "1" setting.

5.10.1.7 Switching programs with the standard torch trigger (P8)

Special latched (latched absolute program sequence)

- Cycle 1: absolute program 1 is run
- Cycle 2: absolute program 2 is run after completion of "tstart".
- Cycle 3: absolute program 3 is run until the "t3" time has elapsed. The program then switches automatically to absolute program 4.

Accessory components such as remote controls or special torches may not be connected!

Program switching at the wire feed unit control is disabled.

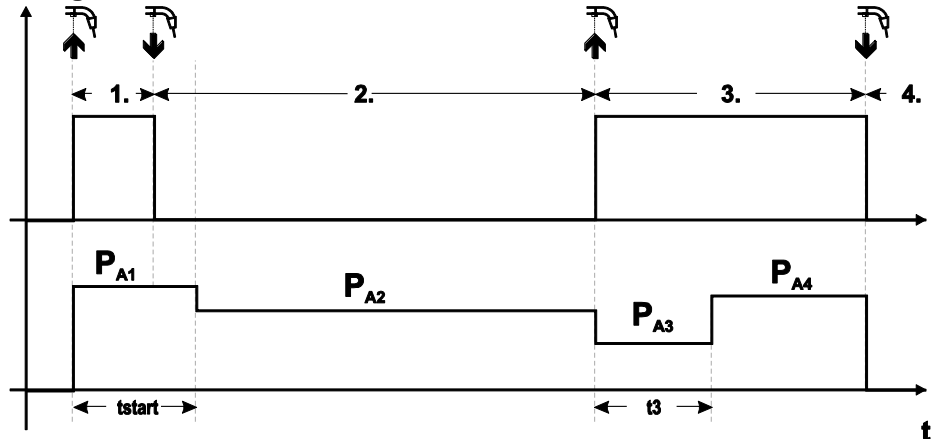

Figure 5-43

Specific latched special (n cycle)

In the n cycle program sequence, the unit starts in the 1st cycle with start program P_{start} from P_1

In the second cycle, the machine switches to absolute program 2, once the start time "tstart" has elapsed.

Tapping switches to other programs (P_{A1} to max. P_{A9}).

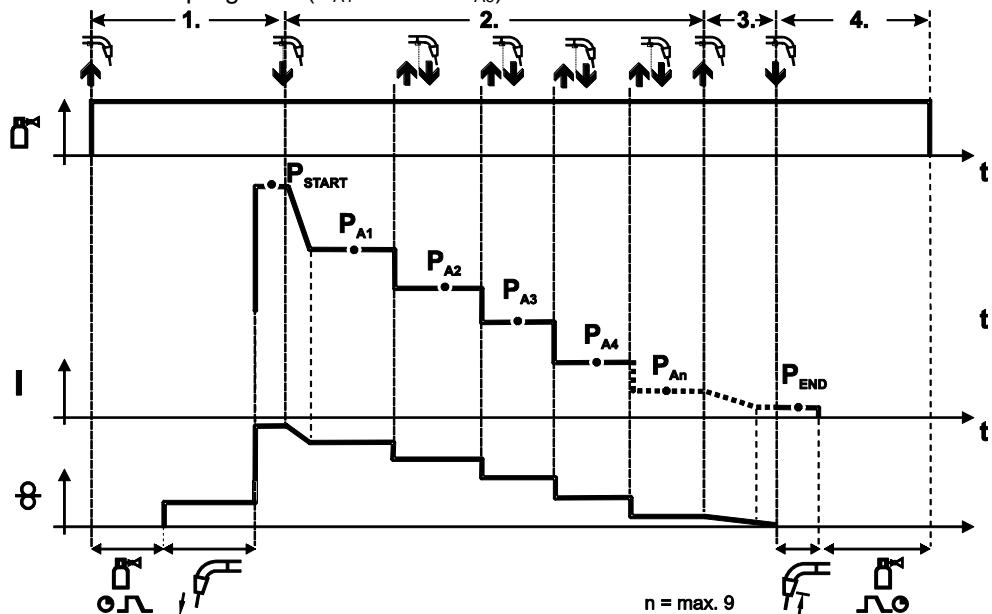

Figure 5-44

The number of programs (P_{An}) corresponds to the cycle number specified under N cycle.

1st cycle

- Press and hold torch trigger.
- Shielding gas is expelled (gas pre-flows).
- Wire feed motor runs at "creep speed".
- Arc ignites after the wire electrode makes contact with the workpiece, welding current is flowing (start program P_{START} from P_{A1})

2nd cycle

- Release torch trigger.
- Slope to main program P_{A1} .

The slope to main program P_{A1} is given at the earliest after the set time t_{START} elapses and at the latest when the torch trigger is released. Tapping (pressing briefly and releasing within 0.3 sec) can switch to other programs. Programs P_{A1} to P_{A9} are possible.

3rd cycle

- Press and hold torch trigger.
- Slope to end program P_{END} from P_{AN} . The program can be stopped at any time by pressing the torch trigger longer than 0.3 sec. P_{END} from P_{AN} is then executed.

4th cycle

- Release torch trigger.
- WF motor stops.
- Arc is extinguished after the pre-selected wire burn-back time elapses.
- Gas post-flow time elapses.

5.10.1.8 Latched/special-latched tap start (P9)

In latched – tap start – operating mode it is possible to switch straight to the second step by tapping the torch trigger; it is not necessary for current to be flowing.

The welding can be halted by pressing the torch trigger for a second time.

5.10.1.9 "Single or dual operation" (P10) setting

 ***If the system is fitted with two wire feeds, no further accessory components may be operated on the 7-pole connection socket (digital)!***

This relates to digital remote controls, robot interfaces, documentation interfaces, welding torches with digital control lead connection, etc.

No second wire feed may be connected in single operation ($P10 = 0$)!

- Remove connections to the second wire feed

In dual operation ($P10 = 1$ or 2), both wire feed units must be connected and configured differently on the controls for this operating mode!

- Configure one wire feed unit as the master ($P10 = 1$)
- Configure the other wire feed unit as a slave ($P10 = 2$)

Wire feed units with key switches (optional, > see 5.8 chapter) must be configured as masters ($P10 = 1$).

The wire feed configured as the master is active after the welding machine is switched on. There are no other functional differences between the wire feeds.

5.10.1.10 Latched special tapping time setting (P11)

The tapping time for changing over between the main program and reduced main program can be set in three levels.

0 = no tapping

1 = 320ms (factory setting)

2 = 640ms

5.10.1.11 JOB list switching (P12)

Value	Name	Explanation
0	Task-based JOB list	JOB numbers are sorted by welding wires and shielding gases. When selecting, the JOB numbers may be skipped.
1	Real JOB list	JOB numbers correspond to the actual memory cells. Every job can be selected, there will be no memory cells if the selection will be skipped.
2	Real JOB list, JOB switching active	Like real JOB list. In addition JOB switching with appropriate accessory components such as a function torch is possible.

Creating user-defined JOB lists

An associated memory area, in which switching with accessory components such as a function torch between JOBS is possible, is created.

- Set special parameters P12 to "2".
- Set switch "Program or Up/Down Function" to "Up/Down" position.
- Select existing JOB, which comes as close as possible to the desired result.
- Copy JOB to one or more destination JOB numbers.

If JOB parameters still need to be adjusted, select destination JOBS one after the other and adjust parameters individually.

- Special parameters P13 to the lower limit and
- Adjust special parameters P14 to the upper limit of the destination JOBS.
- Set switch "Program or Up/down function" to position "Program".

With the accessory component JOBS can be switched in the specified range.

Copying JOBS, "Copy to" function

The possible target range is between 129 - 169.

- First configure special parameter P12 to P12 = 2 or P12 = 1!



Copy JOB by number, see corresponding operating instructions ("Control").

By repeating the last two steps, the same source JOB can be copied to multiple target JOBS.

If the control does not register any user activity for longer than 5 seconds, the parameter display is shown once more and the copy process is complete.

5.10.1.12 Lower and upper limits of the remote JOB changeover process (P13, P14)

The highest and lowest JOB numbers which can be selected using accessory components, such as the PowerControl 2 torch.

Avoids an accidental changeover into undesirable or undefined JOBS.

5.10.1.13 Hold function (P15)

Hold function active (P15 = 1)

- Mean values for the last main program parameters used for welding are displayed.

Hold function not active (P15 = 0)

- Setpoint values for the main program parameters are displayed.

5.10.1.14 Block JOB mode (P16)

The following accessory components support block JOB mode:

- Up/Down welding torch with one-digit 7-segment display (two keys)
Program 0 is always active in JOB 0 and program 1 in all other JOBS

In this operating mode, a total of 27 JOBS (welding tasks) divided into three blocks can be called up using accessory components.

The following settings must be made in order to be able to use block JOB mode:

- Switch the "Program or Up/Down function" changeover switch to "Program"
- Set the JOB list to actual JOB list (special parameter P12 = "1")
- Enable block JOB mode (special parameter P16 = "1")
- Change to block JOB mode by selecting one of the special JOBS 129, 130 or 131.

Simultaneous operation with interfaces such as RINT X12, BUSINT X11, DVINT X11 or digital accessory components such as is the R40 remote control is not possible!

Allocation of JOB numbers to the display on the accessory components

JOB no.	Display/selection on the accessory component									
	0	1	2	3	4	5	6	7	8	9
Special JOB 1	129	141	142	143	144	145	146	147	148	149
Special JOB 2	130	151	152	153	154	155	156	157	158	159
Special JOB 3	131	161	162	163	164	165	166	167	168	169

JOB 0:

This JOB allows you to set the welding parameters manually.

Selection of JOB 0 can be prevented via the key switch or with the "block program 0" parameter (P2).

Key switch position 0, or special parameter P2 = 0: JOB 0 is blocked.

Key switch position 1, or special parameter P2 = 1: JOB 0 can be selected.

JOBS 1-9:

Nine JOBS can be called up in each special JOB (see table).

Nominal values for wire speed, arc correction, dynamics etc must be defined in advance in these JOBS. This can be done easily with the PC300.NET software.

If the software is not available, user-defined JOB lists can be created in the special JOB areas with the "Copy to" function. (See explanations about this in the "Switching JOB lists (P12)" chapter)

5.10.1.15 Selecting programs with the standard torch trigger (P17)

Allows you to select a program or switch a program before starting welding.

You switch to the next program by tapping the torch trigger. Once the last enabled program is reached, you start again at the beginning.

- Program 0 is the first enabled program, provided that it is not blocked. (see also special parameter P2).
- The last enabled program is P15.
 - If the programs are not limited by special parameter P4 (see special parameter P4).
 - Or if the programs are limited for the selected JOB by the n cycle setting (see parameter P8).
- Welding starts when the torch trigger is held for longer than 0.64 s.

You can select programs with the standard torch trigger in all operating modes (non-latched, special non-latched, latched and special latched).

5.10.1.16 Mean value display for superPuls (P19)

Function active (P19 = 1)

- For superPuls, the performance **mean value** from program A (P_A) and program B (P_B) is shown on the display (ex factory).

Function inactive (P19 = 0)

- Only the performance of program A is displayed for superPuls.



If the function is enabled and only "000" is shown on the machine display, this is a rare case of an incompatible system set-up. Solution: Disable special parameter P19.

5.10.1.17 Predefined execution of the pulsed arc welding process in the PA program (P20)

 **For machine versions with pulsed arc welding procedures only.**

Function active (P20 = 1)

- If the superPuls and welding process switching functions are available and activated, the pulse arc welding process is always executed in the main program PA (ex factory).

Function inactive (P20 = 0)

- Predefined execution of the pulse arc welding process in the PA program is disabled.

5.10.1.18 Predefined absolute value for relative programs (P21)

Start program (P_{START}), down-slope program (P_B) and end program (P_{END}) can be set relative to the main program (P_A) or in an absolute manner, as desired.

Function active (P21 = 1)

- Absolute parameter setting

Function inactive (P21 = 0)

- Relative parameter setting (ex factory)

5.10.1.19 Electronic gas flow control, type (P22)

Active only in machines with integrated gas flow control (option ex works).

Adjustment may only be carried out by authorised service personnel (basic setting = 1).

5.10.1.20 Program settings for relative programs (P23)

The start, down-slope and end program relative programs can be set individually or combined for the P0-P15 operating points. When choosing the combined setting, in contrast to the individual setting, the parameter values are saved in the JOB. With the individual setting, the parameter values are identical for all JOBS (except for special JOBS SP1, SP2 and SP3).

5.10.1.21 Correction or nominal voltage display (P24)

When setting the arc correction using the right-hand rotary knob the display will either show the correction voltage +/- 9.9 V (ex works) or the absolute nominal voltage.

5.10.1.22 JOB selection in Expert mode (P25)

The special parameter P25 can be used to specify whether the special JOBS SP1/2/3 or the welding job selection according to the JOB list can be selected on the wire feeder.

5.10.1.23 Nominal value wire heater (P26)

Preheating the welding wire in the temperature range of 25°C - 50°C. Setting 45°C ex works.

5.10.1.24 Mode switching at welding start (P27)

With the selected 4-cycle-Special mode, the user can determine by the time of the torch trigger operation in which operating mode (4-cycle or 4-cycle-Special) the program sequence shall be carried out.

Hold torch trigger (longer than 300 ms): Program sequence with operating mode 4-cycle-Special (standard).

Tap torch trigger: Device changes to operating mode 4-cycle.

5.10.1.25 Error threshold electronic gas flow control (P28)

The set percentage value is the error threshold; if it is undershot or exceeded, an error message > see 5.7.1 chapter is displayed.

5.10.1.26 Units system (P29)**Function not active**

- Metric metric units are displayed.

Function active

- Imperial units are displayed.

5.10.1.27 Selection option – Program sequence with welding power rotary knob (P30)**Function not active**

- The rotary knob is locked, use the welding parameters push-button to select the welding parameters.

Function active

- Rotary knob can be used to select the welding parameters.

5.10.2 Reset to factory settings

All special parameters saved by the user will be overwritten by the factory settings!

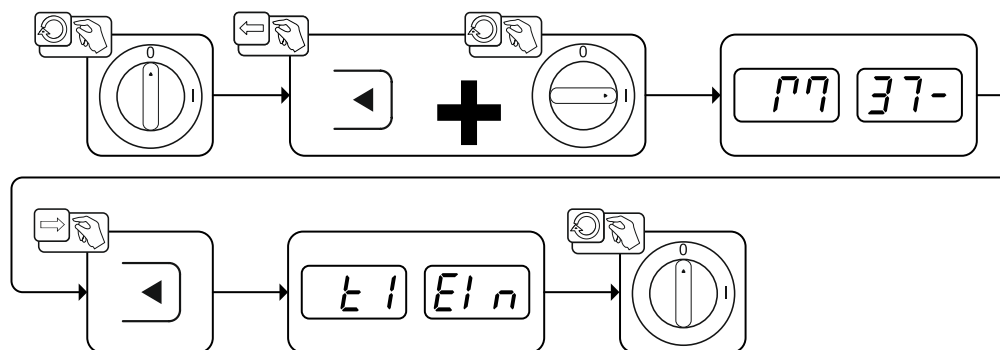

Figure 5-45

5.11 Machine configuration menu

5.11.1 Selecting, changing and saving parameters

Changes to the welding parameters are only possible if the key switch is set to key position .

If the Xbutton function is activated, the key switch function is deactivated (see corresponding operating instructions "Control").

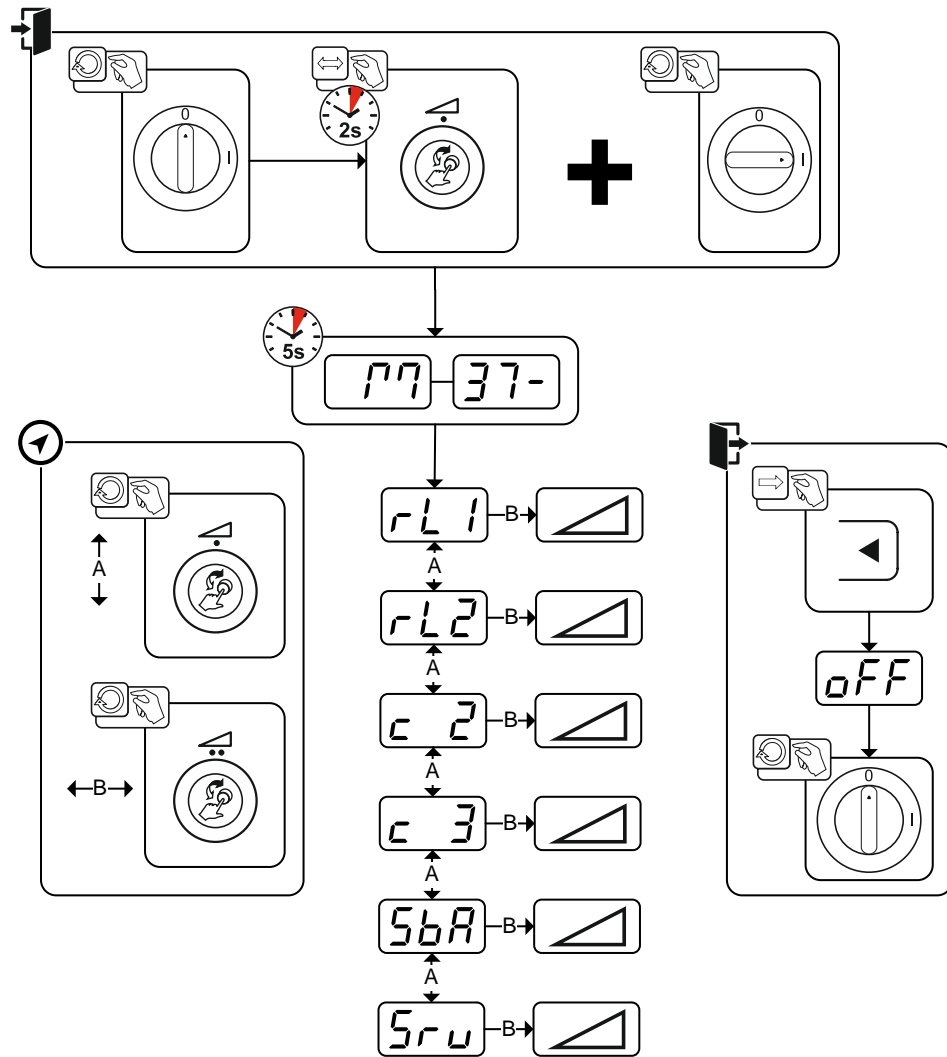

Figure 5-46

Display	Setting/selection
	Lead resistance 1 Lead resistance for the first welding circuit 0 mΩ–60 mΩ (8 mΩ ex works).
	Lead resistance 2 Lead resistance for the second welding circuit 0 mΩ–60 mΩ (8 mΩ ex works).
	Only qualified service personnel may change the parameters!
	Only qualified service personnel may change the parameters!
	Time-based power-saving mode > see 5.11.3 chapter Time to activation of the power-saving mode in case of inactivity. Setting = disabled or numerical value 5– 60 min. (ex works: 20).
	Service menu Modifications to the service menu may only be carried out by authorised maintenance staff!

5.11.2 Aligning the cable resistance

The resistance value of cables can either be set directly or it can be aligned using the power source. The factory setting of the power sources is 8 mΩ. This value corresponds to a 5 m earth cable, a 1.5 m intermediate hose package and a 3 m water-cooled welding torch. With other hose package lengths, it is necessary to carry out a +/- voltage correction to optimise welding properties. The voltage correction value can be set close to zero by means of realigning the cable resistance. It is recommended to align the electric cable resistance after replacing accessories such as torches or intermediate hose packages.

In case a second wire feeder is used the (rL2) parameter has to be aligned. For all other configurations it is sufficient to align the (rL1) parameter.

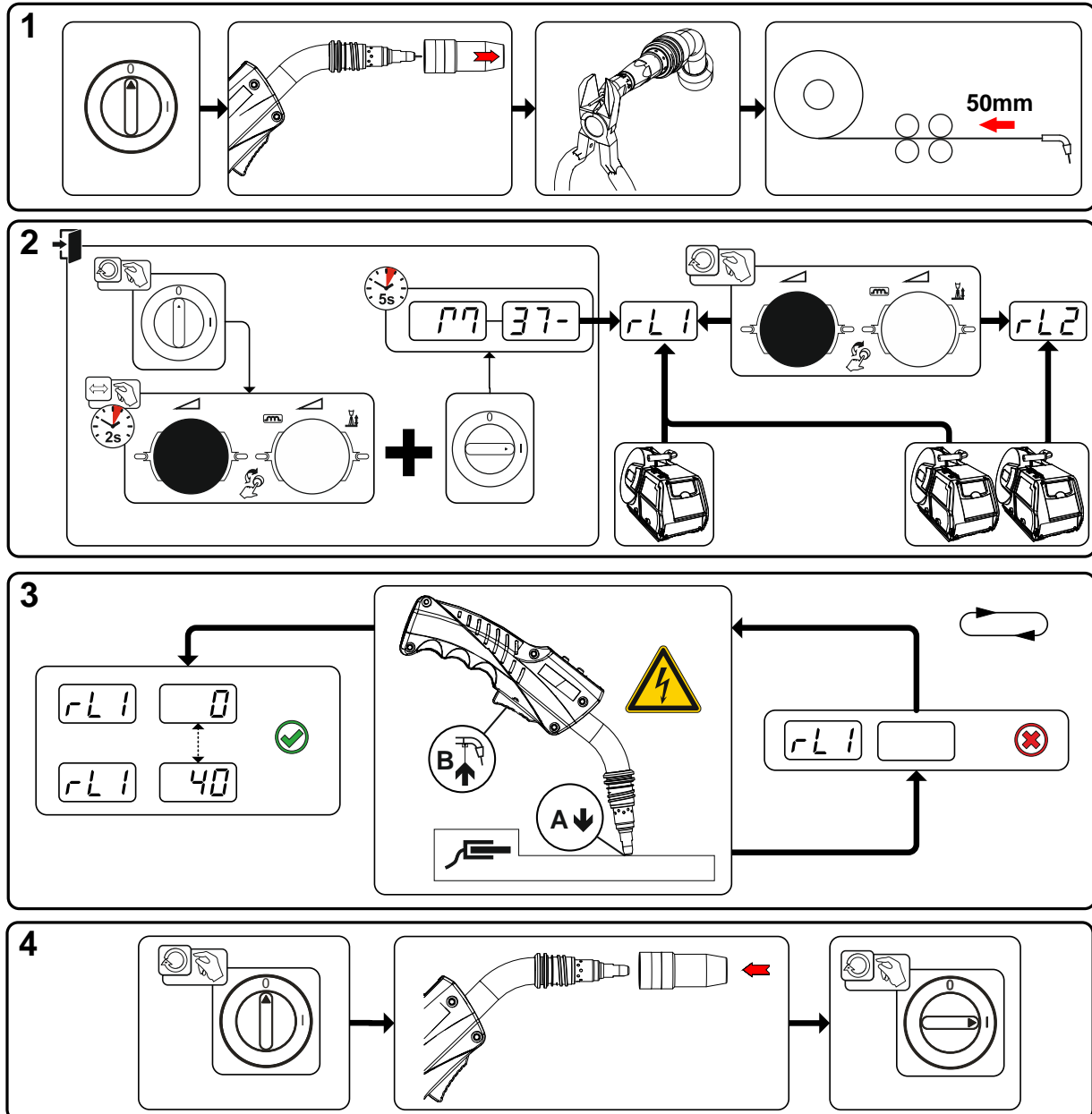

Figure 5-47

1 Preparation

- Switch off the welding machine.
- Unscrew the gas nozzle from the welding torch.
- Trim the welding wire so that it is flush with the contact tip.
- Retract the welding wire a little (approx. 50 mm) on the wire feeder. There should now be no more welding wire in the contact tip.

2 Configuration

- Press and hold "Welding power rotary knob", at the same time switch on the welding machine (at least 2 s). Release rotary knob (device changes after a further 5 s to the first parameter cable resistance 1).
- Turn the "Welding power rotary knob" to select the appropriate parameter. Parameter rL1 must be adjusted for all machine combinations. In case of welding systems with a second power circuit – if two wire feeders are to be operated from a single power source, for example – a second adjustment with parameter rL2 must be performed.

3 Alignment/Measurement

- Applying slight pressure, put the welding torch in place with the contact tip on a clean, purged location on the workpiece and then press the torch trigger for approx. 2 seconds. A short-circuit current will flow briefly, which is used to determine and display the cable resistance. The value can be between 0 mΩ and 40 mΩ. The new value is immediately saved without requiring further confirmation. If no value is shown on the right-hand display, then measurement failed. The measurement must be repeated.

4 Restoring welding standby mode

- Switch off the welding machine.
- Screw the gas nozzle onto the welding torch.
- Switch on the welding machine.
- Insert the welding wire.

5.11.3 Power-saving mode (Standby)

You can activate the power-saving mode by setting a parameter in the machine configuration menu (time-controlled power-saving mode [5.6.1](#)) > see 5.11 chapter.



When power-saving mode is activated, the machine displays show the horizontal digit in the centre of the display only.

Pressing any operating element (e.g. turning a rotary knob) deactivates power-saving mode and the machine is ready for welding again.

6 Rectifying faults

All products are subject to rigorous production checks and final checks. If, despite this, something fails to work at any time, please check the product using the following flowchart. If none of the fault rectification procedures described leads to the correct functioning of the product, please inform your authorised dealer.

6.1 Display machine control software version

The query of the software versions only serves to inform the authorised service staff. It is available in the machine configuration menu > see 5.11 chapter.

6.2 Error messages (power source)



A welding machine error will be signalled by an error code (see table) on the control display. In the event of an error, the power unit shuts down.



The display of possible error numbers depends on the machine version (interfaces/functions).

- Document machine warning and inform service personnel, if required.
- If there are several errors in a control system of "LP" or "HP" type, the error with the lowest error number (Err) is displayed. If this error is corrected, the next higher error number appears. This process is repeated until all errors have been resolved.

Categories legend (resetting the error)

- The error message will disappear once the error has been rectified.
- The error message can be reset by pressing a push-button .
- The error message can only be reset by switching the machine off and on again.

Err	Category			Error	Possible cause	Remedy
	a)	b)	c)			
3	✓	✓	✗	Tacho error	Error of wire feeder	Check connections (connections, pipes)
					Permanent overload of the wire drive	Do not place liner in tight radii, check wire core for smooth movement
4	✓	✗	✗	Excess temperature	Power source overheated	Allow the power source to cool down (mains switch to "1")
					Fan blocked, dirty or defective	Check fan and clean or replace
					Air inlet or outlet blocked	Check air inlet and outlet
5	✗	✗	✓	Mains overvoltage	Mains voltage is too high	Check the mains voltages and compare with the power source connection voltages
6	✗	✗	✓	Mains undervoltage	Mains voltage is too low	
7	✗	✓	✗	Lack coolant	Flow rate too low (≤ 0.7 l/min) / (≤ 0.18 gal./min) ^[1]	Check coolant flow, clean water block, remove kinks in hose package, adjust flow threshold
					Coolant volume too low	Fill coolant
					Pump does not run	Turn the pump shaft
					Air in the coolant circuit	Vent coolant circuit
					Hose package not completely filled with coolant	Switch device off/on, pump runs for 2 min
					Operation with gas-cooled welding torch	Connect coolant feed and coolant return (insert hose bridge) Disable water block

Err	Category			Error	Possible cause	Remedy
	a)	b)	c)			
					Fuse failure F3 (4A) on printed circuit board VB xx0	Inform the service
8	✓	✓	✗	Shielding gas error ^[2]	No shielding gas	Check shielding gas supply
					Pre-pressure too low	Remove kinks in the hose package; nominal value: 4-6 bar pre-pressure
9	✗	✗	✓	Sec. overvoltage	Overvoltage at output: Inverter error	Inform the service
10	✗	✗	✓	Earth fault	Electrical connection between welding wire and housing	Check wire space, eliminate connection
					Electrical connection between welding circuit, housing and earthed objects	Check housing, eliminate connection
11	✓	✓	✗	Quick shut-down	Removing the logical signal "robot ready" during the process	Eliminate errors on the higher-level control
22	✓	✗	✗	Coolant excess temperature	Coolant overheated ($\geq 70^{\circ}\text{C}$ / $\geq 158^{\circ}\text{F}$) ^[1] measured in the coolant return line	Allow the power source to cool down (mains switch to "1")
					Fan blocked, dirty or defective	Check fan, clean or replace
					Air inlet or outlet blocked	Check air inlet and outlet
48	✗	✓	✗	Ignition error	During a process start with an automated system, no ignition has taken place	Check the wire feeding, check the connections of the load cables in the welding circuit, clean corroded surfaces on the workpiece before welding if applicable
49	✗	✓	✗	Arc interruption	While welding with an automated system, there was an arc interruption	Check wire feeding, adjust welding speed.
51	✓	✗	✗	Emergency stop	The emergency stop circuit of the power source has been activated.	Disable the activation of the emergency stop circuit (release protective circuit)
52	✗	✗	✓	No wire feeder	After switching on the automated system, no wire feeder was detected	Check or connect control lines of the wire feed units; correct the identification number of the automated wire feed units (with 1WF: number 1, in 2WF each with a wire feeder number 1 and a wire feeder number 2)
53	✗	✓	✗	No wire feeder 2	Wire feeder 2 not detected	Check or connect the control lines of the wire feed units
54	✗	✗	✓	VRD error	Open circuit voltage reduction error	if necessary, disconnect external device from the welding circuit; notify the service
55	✗	✓	✗	WF excess current	Overcurrent detection on wire feeder	Do not place liner in tight radii; check wire core for smooth movement
56	✗	✗	✓	Mains phase failure	One phase of the mains voltage has failed	Check mains connection, mains plug and mains fuses

Err	Category			Error	Possible cause	Remedy
	a)	b)	c)			
57	✗	✓	✗	Slave tachometer error	Wire feeder fault (slave drive)	Check connectors, cables, connections
					Permanent overload of the wire drive (slave drive)	Do not place liner in tight radii; check wire core for smooth movement
58	✗	✓	✗	Short circuit	Check welding circuit for short circuit	Check welding circuit; isolate welding torch before depositing
59	✗	✗	✓	Incompatible device	A device connected to the system is not compatible	Please disconnect the incompatible device from the system
60	✗	✗	✓	Software incompat.	A machine's software is not compatible.	Inform the service
61	✗	✓	✗	Welding monitor	The actual value of a welding parameter is outside the specified tolerance field	Observe tolerance fields, adjust welding parameters

^[1] ex works

^[2] Option

6.3 Warnings



A warning is denoted by the letter A on the machine display, or Att in case of multiple machine displays. The possible cause of the warning is signalled by the respective warning code (see table).

- In case of multiple warnings, these are displayed in sequence.
- Document machine warning and inform service personnel, if required.

Att	Warning	Possible cause
1	Excess temperature	Shut-down due to excess temperature imminent.
4	Shielding gas ^[2]	Check shielding gas supply.
5	Coolant flow	Flow rate ($\leq 0.7\text{l/min}$ / $\leq 0.18\text{ gal./min}$) ^[1]
6	low wire	Nearly no wire left on the spool.
7	CAN bus failure	Wire feeder not connected, automatic circuit-breaker of wire feed motor (reset triggered machine by pressing).
8	Welding circuit	The welding circuit inductance is too high for the selected welding task.
10	Partial inverter	One of several partial inverters is not supplying welding current.
11	Excess temperature, coolant	Coolant ($\geq 65^\circ\text{C}$ / $\geq 149^\circ\text{F}$) ^[1]
12	Welding monitor	The actual value of a welding parameter is outside the specified tolerance field.
32	Tacho error	Fault of wire feeder, permanent overload of the wire drive.
33	WF excess current	Overcurrent detection of the wire main drive.
34	JOB unknown	JOB selection was not performed because the JOB number is unknown.
35	WF excess current slave	Overload of the slave wire drive (front drive push/push system or intermediate drive).
36	Slave tachometer error	Fault of wire feeder, permanent overload of the slave wire drive (front drive push/push system or intermediate drive).

^[1] ex works

^[2] Option

6.4 Resetting JOBS (welding tasks) to the factory settings

All customised welding parameters that are stored will be replaced by the factory settings.

6.4.1 Resetting a single JOB

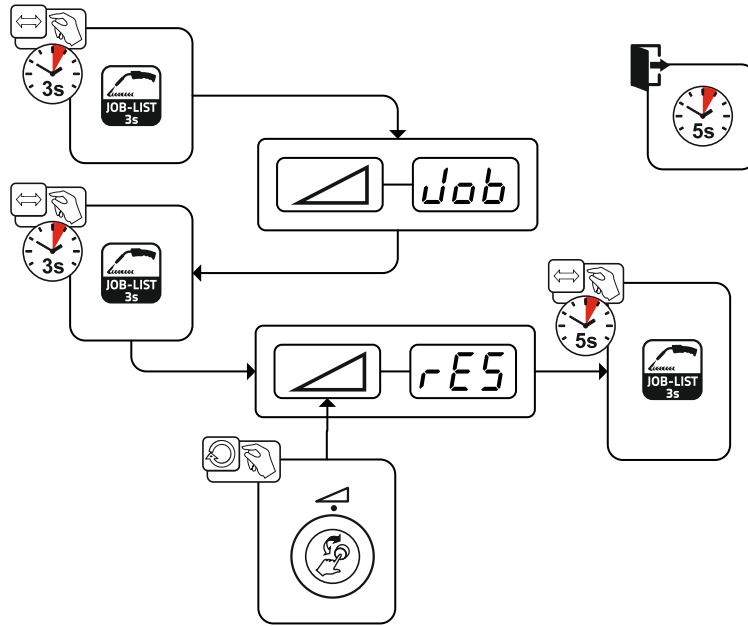

Figure 6-1

6.4.2 Resetting all JOBS

JOBS 1–128 and 170–256 will be reset.
Custom JOBS 129–169 are maintained.

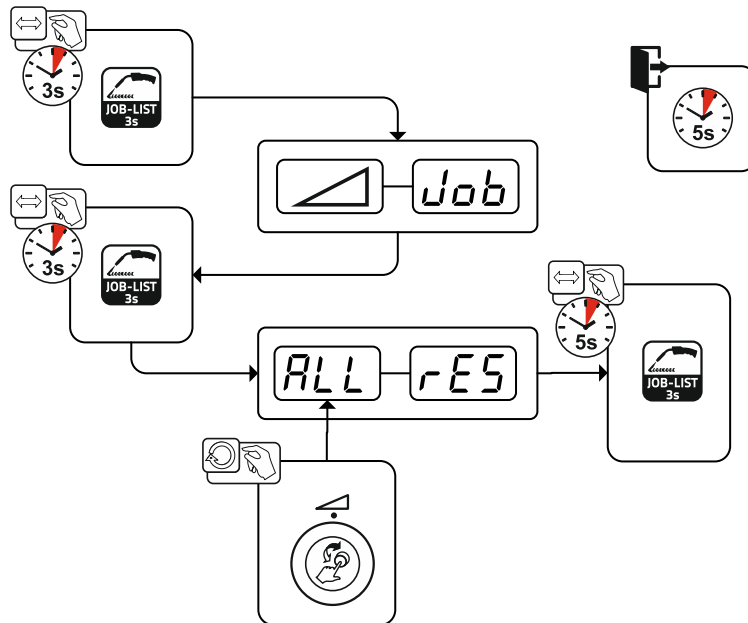

Figure 6-2

7 Appendix A

7.1 JOB-List

JOB no.	Processes	Material	Gas	Diameter [mm]
1	Standard GMAW	G3Si1 / G4Si1	100% CO2	0,8
2	Standard GMAW	G3Si1 / G4Si1	100% CO2	0,9
3	Standard GMAW	G3Si1 / G4Si1	100% CO2	1,0
4	Standard GMAW	G3Si1 / G4Si1	100% CO2	1,2
5	Standard GMAW	G3Si1 / G4Si1	100% CO2	1,6
6	Standard GMAW / puls	G3Si1 / G4Si1	Ar-82 / CO2-18 (M21)	0,8
7	Standard GMAW / puls	G3Si1 / G4Si1	Ar-82 / CO2-18 (M21)	0,9
8	Standard GMAW / puls	G3Si1 / G4Si1	Ar-82 / CO2-18 (M21)	1,0
9	Standard GMAW / puls	G3Si1 / G4Si1	Ar-82 / CO2-18 (M21)	1,2
10	Standard GMAW / puls	G3Si1 / G4Si1	Ar-82 / CO2-18 (M21)	1,6
11	Standard GMAW / puls	G3Si1 / G4Si1	Ar-90 / CO2-10 (M20)	0,8
12	Standard GMAW / puls	G3Si1 / G4Si1	Ar-90 / CO2-10 (M20)	0,9
13	Standard GMAW / puls	G3Si1 / G4Si1	Ar-90 / CO2-10 (M20)	1,0
14	Standard GMAW / puls	G3Si1 / G4Si1	Ar-90 / CO2-10 (M20)	1,2
15	Standard GMAW / puls	G3Si1 / G4Si1	Ar-90 / CO2-10 (M20)	1,6
26	Standard GMAW / puls	CrNi 19 12 3 Nb / 1.4576	Ar-97,5 / CO2-2,5 (M12)	0,8
27	Standard GMAW / puls	CrNi 19 12 3 Nb / 1.4576	Ar-97,5 / CO2-2,5 (M12)	1,0
28	Standard GMAW / puls	CrNi 19 12 3 Nb / 1.4576	Ar-97,5 / CO2-2,5 (M12)	1,2
29	Standard GMAW / puls	CrNi 19 12 3 Nb / 1.4576	Ar-97,5 / CO2-2,5 (M12)	1,6
30	Standard GMAW / puls	CrNi 18 8 / 1.4370	Ar-97,5 / CO2-2,5 (M12)	0,8
31	Standard GMAW / puls	CrNi 18 8 / 1.4370	Ar-97,5 / CO2-2,5 (M12)	1,0
32	Standard GMAW / puls	CrNi 18 8 / 1.4370	Ar-97,5 / CO2-2,5 (M12)	1,2
33	Standard GMAW / puls	CrNi 18 8 / 1.4370	Ar-97,5 / CO2-2,5 (M12)	1,6
34	Standard GMAW / puls	CrNi 19 9 / 1.4316	Ar-97,5 / CO2-2,5 (M12)	0,8
35	Standard GMAW / puls	CrNi 19 9 / 1.4316	Ar-97,5 / CO2-2,5 (M12)	1,0
36	Standard GMAW / puls	CrNi 19 9 / 1.4316	Ar-97,5 / CO2-2,5 (M12)	1,2
37	Standard GMAW / puls	CrNi 19 9 / 1.4316	Ar-97,5 / CO2-2,5 (M12)	1,6
38	Standard GMAW / puls	CrNi 19 12 3 / 1.4430	Ar-97,5 / CO2-2,5 (M12)	0,8
39	Standard GMAW / puls	CrNi 19 12 3 / 1.4430	Ar-97,5 / CO2-2,5 (M12)	1,0
40	Standard GMAW / puls	CrNi 19 12 3 / 1.4430	Ar-97,5 / CO2-2,5 (M12)	1,2
41	Standard GMAW / puls	CrNi 19 12 3 / 1.4430	Ar-97,5 / CO2-2,5 (M12)	1,6
42	Standard GMAW / puls	CrNi 22 9 3 / 1.4462	Ar-97,5 / CO2-2,5 (M12)	0,8
43	Standard GMAW / puls	CrNi 22 9 3 / 1.4462	Ar-97,5 / CO2-2,5 (M12)	1,0
44	Standard GMAW / puls	CrNi 22 9 3 / 1.4462	Ar-97,5 / CO2-2,5 (M12)	1,2
45	Standard GMAW / puls	CrNi 22 9 3 / 1.4462	Ar-97,5 / CO2-2,5 (M12)	1,6
46	Standard GMAW / puls	CrNi 22 9 3 / 1.4462	Ar-78 / He-20 / CO2-2 (M12)	0,8
47	Standard GMAW / puls	CrNi 22 9 3 / 1.4462	Ar-78 / He-20 / CO2-2 (M12)	1,0
48	Standard GMAW / puls	CrNi 22 9 3 / 1.4462	Ar-78 / He-20 / CO2-2 (M12)	1,2

JOB no.	Processes	Material	Gas	Diameter [mm]
49	Standard GMAW / puls	CrNi 22 9 3 / 1.4462	Ar-78 / He-20 / CO2-2 (M12)	1,6
50	coldArc / coldArc puls	CrNi 19 9 / 1.4316	Ar-97,5 / CO2-2,5 (M12)	0,8
51	coldArc / coldArc puls	CrNi 19 9 / 1.4316	Ar-97,5 / CO2-2,5 (M12)	1,0
52	coldArc / coldArc puls	CrNi 19 9 / 1.4316	Ar-97,5 / CO2-2,5 (M12)	1,2
55	coldArc / coldArc puls	AlMg4,5Mn	Ar-100 (I1)	1,0
56	coldArc / coldArc puls	AlMg4,5Mn	Ar-100 (I1)	1,2
59	coldArc / coldArc puls	AlSi	Ar-100 (I1)	1,0
60	coldArc / coldArc puls	AlSi	Ar-100 (I1)	1,2
63	coldArc / coldArc puls	Al99	Ar-100 (I1)	1,0
64	coldArc / coldArc puls	Al99	Ar-100 (I1)	1,2
66	coldArc Brazing	CuSi	Ar-100 (I1)	0,8
67	coldArc Brazing	CuSi	Ar-100 (I1)	1,0
68	coldArc Brazing	CuSi	Ar-100 (I1)	1,2
70	coldArc Brazing	CuAl	Ar-100 (I1)	0,8
71	coldArc Brazing	CuAl	Ar-100 (I1)	1,0
72	coldArc Brazing	CuAl	Ar-100 (I1)	1,2
74	Standard GMAW / puls	AlMg4,5Mn	Ar-100 (I1)	0,8
75	Standard GMAW / puls	AlMg4,5Mn	Ar-100 (I1)	1,0
76	Standard GMAW / puls	AlMg4,5Mn	Ar-100 (I1)	1,2
77	Standard GMAW / puls	AlMg4,5Mn	Ar-100 (I1)	1,6
78	Standard GMAW / puls	AlMg4,5Mn	Ar-70 / He-30 (I3)	0,8
79	Standard GMAW / puls	AlMg4,5Mn	Ar-70 / He-30 (I3)	1,0
80	Standard GMAW / puls	AlMg4,5Mn	Ar-70 / He-30 (I3)	1,2
81	Standard GMAW / puls	AlMg4,5Mn	Ar-70 / He-30 (I3)	1,6
82	Standard GMAW / puls	AlSi	Ar-100 (I1)	0,8
83	Standard GMAW / puls	AlSi	Ar-100 (I1)	1,0
84	Standard GMAW / puls	AlSi	Ar-100 (I1)	1,2
85	Standard GMAW / puls	AlSi	Ar-100 (I1)	1,6
86	Standard GMAW / puls	AlSi	Ar-70 / He-30 (I3)	0,8
87	Standard GMAW / puls	AlSi	Ar-70 / He-30 (I3)	1,0
88	Standard GMAW / puls	AlSi	Ar-70 / He-30 (I3)	1,2
89	Standard GMAW / puls	AlSi	Ar-70 / He-30 (I3)	1,6
90	Standard GMAW / puls	Al99	Ar-100 (I1)	0,8
91	Standard GMAW / puls	Al99	Ar-100 (I1)	1,0
92	Standard GMAW / puls	Al99	Ar-100 (I1)	1,2
93	Standard GMAW / puls	Al99	Ar-100 (I1)	1,6
94	Standard GMAW / puls	Al99	Ar-70 / He-30 (I3)	0,8
95	Standard GMAW / puls	Al99	Ar-70 / He-30 (I3)	1,0
96	Standard GMAW / puls	Al99	Ar-70 / He-30 (I3)	1,2
97	Standard GMAW / puls	Al99	Ar-70 / He-30 (I3)	1,6
98	Standard GMAW / puls	CuSi	Ar-100 (I1)	0,8
99	Standard GMAW / puls	CuSi	Ar-100 (I1)	1,0
100	Standard GMAW / puls	CuSi	Ar-100 (I1)	1,2
101	Standard GMAW / puls	CuSi	Ar-100 (I1)	1,6
102	Standard GMAW / puls	CuSi	Ar-97,5 / CO2-2,5 (M12)	0,8
103	Standard GMAW / puls	CuSi	Ar-97,5 / CO2-2,5 (M12)	1,0

JOB no.	Processes	Material	Gas	Diameter [mm]
104	Standard GMAW / puls	CuSi	Ar-97,5 / CO2-2,5 (M12)	1,2
105	Standard GMAW / puls	CuSi	Ar-97,5 / CO2-2,5 (M12)	1,6
106	Standard GMAW / puls	CuAl	Ar-100 (I1)	0,8
107	Standard GMAW / puls	CuAl	Ar-100 (I1)	1,0
108	Standard GMAW / puls	CuAl	Ar-100 (I1)	1,2
109	Standard GMAW / puls	CuAl	Ar-100 (I1)	1,6
110	Brazing	CuSi	Ar-97,5 / CO2-2,5 (M12)	0,8
111	Brazing	CuSi	Ar-97,5 / CO2-2,5 (M12)	1,0
112	Brazing	CuSi	Ar-97,5 / CO2-2,5 (M12)	1,2
113	Brazing	CuSi	Ar-97,5 / CO2-2,5 (M12)	1,6
114	Brazing	CuSi	Ar-100 (I1)	0,8
115	Brazing	CuSi	Ar-100 (I1)	1,0
116	Brazing	CuSi	Ar-100 (I1)	1,2
117	Brazing	CuSi	Ar-100 (I1)	1,6
118	Brazing	CuAl	Ar-97,5 / CO2-2,5 (M12)	0,8
119	Brazing	CuAl	Ar-97,5 / CO2-2,5 (M12)	1,0
120	Brazing	CuAl	Ar-97,5 / CO2-2,5 (M12)	1,2
121	Brazing	CuAl	Ar-97,5 / CO2-2,5 (M12)	1,6
122	Brazing	CuAl	Ar-100 (I1)	0,8
123	Brazing	CuAl	Ar-100 (I1)	1,0
124	Brazing	CuAl	Ar-100 (I1)	1,2
125	Brazing	CuAl	Ar-100 (I1)	1,6
126	Gouging			
127	TIG Liftarc			
128	MMA			
129	Special JOB 1	Special	Special	Spezial
130	Special JOB 2	Special	Special	Spezial
131	Special JOB 3	Special	Special	Spezial
132		Free JOB		
133		Free JOB		
134		Free JOB		
135		Free JOB		
136		Free JOB		
137		Free JOB		
138		Free JOB		
139		Free JOB		
140		Block 1/ JOB1		
141		Block 1/ JOB2		
142		Block 1/ JOB3		
143		Block 1/ JOB4		
144		Block 1/ JOB5		
145		Block 1/ JOB6		
146		Block 1/ JOB7		
147		Block 1/ JOB8		
148		Block 1/ JOB9		
149		Block 1/ JOB10		
150		Block 2/ JOB1		

JOB no.	Processes	Material	Gas	Diameter [mm]
151		Block 2/ JOB2		
152		Block 2/ JOB3		
153		Block 2/ JOB4		
154		Block 2/ JOB5		
155		Block 2/ JOB6		
156		Block 2/ JOB7		
157		Block 2/ JOB8		
158		Block 2/ JOB9		
159		Block 2/ JOB10		
160		Block 3/ JOB1		
161		Block 3/ JOB2		
162		Block 3/ JOB3		
163		Block 3/ JOB4		
164		Block 3/ JOB5		
165		Block 3/ JOB6		
166		Block 3/ JOB7		
167		Block 3/ JOB8		
168		Block 3/ JOB9		
169		Block 3/ JOB10		
171	pipeSolution	G3Si1 / G4Si1	CO2-100 (C1)	1,0
172	pipeSolution	G3Si1 / G4Si1	CO2-100 (C1)	1,2
173	pipeSolution	G3Si1 / G4Si1	Ar-82 / CO2-18 (M21)	1,0
174	pipeSolution	G3Si1 / G4Si1	Ar-82 / CO2-18 (M21)	1,2
177	Standard GMAW / puls	G3Si1 / G4Si1	Ar-90 / CO2-10 (M20)	1,0
178	Standard GMAW / puls	G3Si1 / G4Si1	Ar-90 / CO2-10 (M20)	1,2
179	forceArc / forceArc puls	G3Si1 / G4Si1	Ar-82 / CO2-18 (M21)	1,0
180	forceArc / forceArc puls	G3Si1 / G4Si1	Ar-82 / CO2-18 (M21)	1,2
181	forceArc / forceArc puls	G3Si1 / G4Si1	Ar-82 / CO2-18 (M21)	1,6
182	coldArc	G3Si1 / G4Si1	CO2-100 (C1)	0,8
183	coldArc	G3Si1 / G4Si1	CO2-100 (C1)	0,9
184	coldArc	G3Si1 / G4Si1	CO2-100 (C1)	1,0
185	coldArc	G3Si1 / G4Si1	CO2-100 (C1)	1,2
188	MSG Non-Synergic	Spezial	Spezial	Spezial
189	forceArc / forceArc puls	G3Si1 / G4Si1	Ar-82 / CO2-18 (M21)	0,8
190	forceArc / forceArc puls	G3Si1 / G4Si1	Ar-90 / CO2-10 (M20)	0,8
191	coldArc / coldArc puls	G3Si1 / G4Si1	Ar-82 / CO2-18 (M21)	0,8
192	coldArc / coldArc puls	G3Si1 / G4Si1	Ar-82 / CO2-18 (M21)	0,9
193	coldArc / coldArc puls	G3Si1 / G4Si1	Ar-82 / CO2-18 (M21)	1,0
194	coldArc / coldArc puls	G3Si1 / G4Si1	Ar-82 / CO2-18 (M21)	1,2
195	coldArc / coldArc puls	G3Si1 / G4Si1	Ar-82 / CO2-18 (M21)	1,6
197	coldArc Brazing	AlSi	Ar-100 (I1)	1,0
198	coldArc Brazing	AlSi	Ar-100 (I1)	1,2
201	coldArc Brazing	ZnAl	Ar-100 (I1)	1,0
202	coldArc Brazing	ZnAl	Ar-100 (I1)	1,2
204	rootArc	G3Si1 / G4Si1	CO2-100 (C1)	1,0
205	rootArc	G3Si1 / G4Si1	CO2-100 (C1)	1,2
206	rootArc / rootArc puls	G3Si1 / G4Si1	Ar-82 / CO2-18 (M21)	1,0

JOB no.	Processes	Material	Gas	Diameter [mm]
207	rootArc / rootArc puls	G3Si1 / G4Si1	Ar-82 / CO2-18 (M21)	1,2
208	coldArc - Mg/Mg	Mg	Ar-70 / He-30 (I3)	1,2
209	coldArc - Mg/Mg	Mg	Ar-70 / He-30 (I3)	1,6
212	Rutile/basic flux cored wire	FCW CrNi - Rutile	CO2-100 (C1)	1,2
213	Rutile/basic flux cored wire	FCW CrNi - Rutile	CO2-100 (C1)	1,6
216	Standard GMAW / puls	AlMg3	Ar-100 (I1)	1,0
217	Standard GMAW / puls	AlMg3	Ar-100 (I1)	1,2
218	Standard GMAW / puls	AlMg3	Ar-100 (I1)	1,6
220	coldArc - St/Al	ZnAl	Ar-100 (I1)	1,0
221	coldArc - St/Al	ZnAl	Ar-100 (I1)	1,2
224	coldArc - St/Al	AlSi	Ar-100 (I1)	1,0
225	coldArc - St/Al	AlSi	Ar-100 (I1)	1,2
229	Metal flux-cored wire	FCW CrNi - Metal	Ar-97,5 / CO2-2,5 (M12)	1,2
230	Metal flux-cored wire	FCW CrNi - Metal	Ar-97,5 / CO2-2,5 (M12)	1,6
233	Rutile/basic flux cored wire	FCW CrNi - Rutile	Ar-82 / CO2-18 (M21)	1,2
234	Rutile/basic flux cored wire	FCW CrNi - Rutile	Ar-82 / CO2-18 (M21)	1,6
235	Metal flux-cored wire	FCW Steel - Metal	Ar-82 / CO2-18 (M21)	0,8
237	Metal flux-cored wire	FCW Steel - Metal	Ar-82 / CO2-18 (M21)	1,0
238	Metal flux-cored wire	FCW Steel - Metal	Ar-82 / CO2-18 (M21)	1,2
239	Metal flux-cored wire	FCW Steel - Metal	Ar-82 / CO2-18 (M21)	1,6
240	Rutile/basic flux cored wire	FCW CrNi - Rutile	Ar-82 / CO2-18 (M21)	0,8
242	Rutile/basic flux cored wire	FCW CrNi - Rutile	Ar-82 / CO2-18 (M21)	1,0
243	Rutile/basic flux cored wire	FCW CrNi - Rutile	Ar-82 / CO2-18 (M21)	1,2
244	Rutile/basic flux cored wire	FCW CrNi - Rutile	Ar-82 / CO2-18 (M21)	1,6
245	forceArc / forceArc puls	Al99	Ar-100 (I1)	1,2
246	forceArc / forceArc puls	Al99	Ar-100 (I1)	1,6
247	forceArc / forceArc puls	AlMg4,5Mn	Ar-100 (I1)	1,2
248	forceArc / forceArc puls	AlMg4,5Mn	Ar-100 (I1)	1,6
249	forceArc / forceArc puls	AlSi	Ar-100 (I1)	1,2
250	forceArc / forceArc puls	AlSi	Ar-100 (I1)	1,6
251	forceArc / forceArc puls	CrNi 19 9 / 1.4316	Ar-97,5 / CO2-2,5 (M12)	1,0
252	forceArc / forceArc puls	CrNi 19 9 / 1.4316	Ar-97,5 / CO2-2,5 (M12)	1,2
253	forceArc / forceArc puls	CrNi 19 9 / 1.4316	Ar-97,5 / CO2-2,5 (M12)	1,6
254	forceArc / forceArc puls	G3Si1 / G4Si1	Ar-90 / CO2-10 (M20)	1,0
255	forceArc / forceArc puls	G3Si1 / G4Si1	Ar-90 / CO2-10 (M20)	1,2
256	forceArc / forceArc puls	G3Si1 / G4Si1	Ar-90 / CO2-10 (M20)	1,6
260	Rutile/basic flux cored wire	FCW Steel - Rutile	CO2-100 (C1)	1,2
261	Rutile/basic flux cored wire	FCW Steel - Rutile	CO2-100 (C1)	1,6

JOB no.	Processes	Material	Gas	Diameter [mm]
263	Metal flux-cored wire	High tensile steels / Special	Ar-82 / CO2-18 (M21)	1,2
264	Basic flux-cored	FCW Steel - Basic	Ar-82 / CO2-18 (M21)	1,2
268	Auftragschweißen	NiCr 6617 / 2.4627	Ar-70 / He-30 (I3)	1,2
269	Auftragschweißen	NiCr 6617 / 2.4627	Ar-70 / He-30 (I3)	1,6
271	Auftragschweißen	NiCr 6625 / 2.4831	Ar-70 / He-30 (I3)	1,0
272	Auftragschweißen	NiCr 6625 / 2.4831	Ar-70 / He-30 (I3)	1,2
273	Auftragschweißen	NiCr 6625 / 2.4831	Ar-70 / He-30 (I3)	1,6
275	Auftragschweißen	NiCr 6625 / 2.4831	Ar-78 / He-20 / CO2-2 (M12)	1,0
276	Auftragschweißen	NiCr 6625 / 2.4831	Ar-78 / He-20 / CO2-2 (M12)	1,2
277	Auftragschweißen	NiCr 6625 / 2.4831	Ar-78 / He-20 / CO2-2 (M12)	1,6
279	Standard GMAW / puls	CrNi 25 20 / 1.4842	Ar-97,5 / CO2-2,5 (M12)	1,0
280	Standard GMAW / puls	CrNi 25 20 / 1.4842	Ar-97,5 / CO2-2,5 (M12)	1,2
282	Standard GMAW / puls	CrNi 22 12 / 1.4829	Ar-97,5 / CO2-2,5 (M12)	0,8
283	Standard GMAW / puls	CrNi 22 12 / 1.4829	Ar-97,5 / CO2-2,5 (M12)	1,0
284	Standard GMAW / puls	CrNi 22 12 / 1.4829	Ar-97,5 / CO2-2,5 (M12)	1,2
285	Standard GMAW / puls	CrNi 22 12 / 1.4829	Ar-97,5 / CO2-2,5 (M12)	1,6
290	forceArc / forceArc puls Metal flux-cored wire	FCW Steel - Metal	Ar-82 / CO2-18 (M21)	0,8
291	forceArc / forceArc puls Metal flux-cored wire	FCW Steel - Metal	Ar-82 / CO2-18 (M21)	1,0
292	forceArc / forceArc puls Metal flux-cored wire	FCW Steel - Metal	Ar-82 / CO2-18 (M21)	1,2
293	forceArc / forceArc puls Metal flux-cored wire	FCW Steel - Metal	Ar-82 / CO2-18 (M21)	1,6
294	forceArc / puls	G3Si1 / G4Si1	Ar-82 / CO2-18 (M21)	0,8
295	forceArc / puls	G3Si1 / G4Si1	Ar-82 / CO2-18 (M21)	1,0
296	forceArc / puls	G3Si1 / G4Si1	Ar-82 / CO2-18 (M21)	1,2
297	forceArc / puls	G3Si1 / G4Si1	Ar-82 / CO2-18 (M21)	1,6
298	forceArc / puls	G3Si1 / G4Si1	Ar-90 / CO2-10 (M20)	0,8
299	forceArc / puls	G3Si1 / G4Si1	Ar-90 / CO2-10 (M20)	1,0
300	forceArc / puls	G3Si1 / G4Si1	Ar-90 / CO2-10 (M20)	1,2
301	forceArc / puls	G3Si1 / G4Si1	Ar-90 / CO2-10 (M20)	1,6
303	forceArc / forceArc puls	CrNi 19 12 3 Nb / 1.4576	Ar-97,5 / CO2-2,5 (M12)	1,0
304	forceArc / forceArc puls	CrNi 19 12 3 Nb / 1.4576	Ar-97,5 / CO2-2,5 (M12)	1,2
305	forceArc / forceArc puls	CrNi 19 12 3 Nb / 1.4576	Ar-97,5 / CO2-2,5 (M12)	1,6
307	forceArc / forceArc puls	CrNi 18 8 / 1.4370	Ar-97,5 / CO2-2,5 (M12)	1,0
308	forceArc / forceArc puls	CrNi 18 8 / 1.4370	Ar-97,5 / CO2-2,5 (M12)	1,2
309	forceArc / forceArc puls	CrNi 18 8 / 1.4370	Ar-97,5 / CO2-2,5 (M12)	1,6
311	forceArc / forceArc puls	CrNi 19 12 3 / 1.4430	Ar-97,5 / CO2-2,5 (M12)	1,0
312	forceArc / forceArc puls	CrNi 19 12 3 / 1.4430	Ar-97,5 / CO2-2,5 (M12)	1,2
313	forceArc / forceArc puls	CrNi 19 12 3 / 1.4430	Ar-97,5 / CO2-2,5 (M12)	1,6
315	forceArc / forceArc puls	CrNi 22 9 3 / 1.4462	Ar-97,5 / CO2-2,5 (M12)	1,0

JOB no.	Processes	Material	Gas	Diameter [mm]
316	forceArc / forceArc puls	CrNi 22 9 3 / 1.4462	Ar-97,5 / CO2-2,5 (M12)	1,2
317	forceArc / forceArc puls	CrNi 22 9 3 / 1.4462	Ar-97,5 / CO2-2,5 (M12)	1,6
319	forceArc / forceArc puls	CrNi 25 20 / 1.4842	Ar-97,5 / CO2-2,5 (M12)	1,0
320	forceArc / forceArc puls	CrNi 25 20 / 1.4842	Ar-97,5 / CO2-2,5 (M12)	1,2
323	forceArc / forceArc puls	CrNi 23 12 / 1.4332	Ar-97,5 / CO2-2,5 (M12)	1,0
324	forceArc / forceArc puls	CrNi 23 12 / 1.4332	Ar-97,5 / CO2-2,5 (M12)	1,2
325	forceArc / forceArc puls	CrNi 23 12 / 1.4332	Ar-97,5 / CO2-2,5 (M12)	1,6
326	coldArc / coldArc puls	CrNi 19 12 3 Nb / 1.4576	Ar-97,5 / CO2-2,5 (M12)	0,8
327	coldArc / coldArc puls	CrNi 19 12 3 Nb / 1.4576	Ar-97,5 / CO2-2,5 (M12)	1,0
328	coldArc / coldArc puls	CrNi 19 12 3 Nb / 1.4576	Ar-97,5 / CO2-2,5 (M12)	1,2
330	coldArc / coldArc puls	CrNi 18 8 / 1.4370	Ar-97,5 / CO2-2,5 (M12)	0,8
331	coldArc / coldArc puls	CrNi 18 8 / 1.4370	Ar-97,5 / CO2-2,5 (M12)	1,0
332	coldArc / coldArc puls	CrNi 18 8 / 1.4370	Ar-97,5 / CO2-2,5 (M12)	1,2
334	coldArc / coldArc puls	CrNi 19 12 3 / 1.4430	Ar-97,5 / CO2-2,5 (M12)	0,8
335	coldArc / coldArc puls	CrNi 19 12 3 / 1.4430	Ar-97,5 / CO2-2,5 (M12)	1,0
336	coldArc / coldArc puls	CrNi 19 12 3 / 1.4430	Ar-97,5 / CO2-2,5 (M12)	1,2
338	coldArc / coldArc puls	CrNi 22 9 3 / 1.4462 / Duplex	Ar-97,5 / CO2-2,5 (M12)	0,8
339	coldArc / coldArc puls	CrNi 22 9 3 / 1.4462 / Duplex	Ar-97,5 / CO2-2,5 (M12)	1,0
340	coldArc / coldArc puls	CrNi 22 9 3 / 1.4462 / Duplex	Ar-97,5 / CO2-2,5 (M12)	1,2
350	Self-shielded flux cored wire	FCW Steel - Rutile	No Gas	0,9
351	Self-shielded flux cored wire	FCW Steel - Rutile	No Gas	1,0
352	Self-shielded flux cored wire	FCW Steel - Rutile	No Gas	1,2
359	wiredArc / wiredArc puls	G3Si1 / G4Si1	Ar-82 / CO2-18 (M21)	1,0
360	wiredArc / wiredArc puls	G3Si1 / G4Si1	Ar-82 / CO2-18 (M21)	1,2
367	wiredArc / wiredArc puls	CrNi 19 9 / 1.4316	Ar-97,5 / CO2-2,5 (M12)	1,0
368	wiredArc / wiredArc puls	CrNi 19 9 / 1.4316	Ar-97,5 / CO2-2,5 (M12)	1,2
371	wiredArc / wiredArc puls	CrNi 19 12 3 / 1.4430	Ar-97,5 / CO2-2,5 (M12)	1,0
386	Surfacing	Co-based	Ar-100 (I1)	1,2
387	Surfacing	Co-based	Ar-100 (I1)	1,6
388	Surfacing	CrNi 23 12 / 1.4332	Ar-97,5 / CO2-2,5 (M12)	1,2
389	Surfacing	CrNi 23 12 / 1.4332	Ar-97,5 / CO2-2,5 (M12)	1,6

8 Appendix B

8.1 Parameter overview – setting ranges

8.1.1 MIG/MAG welding

Name	Darstellung			Einstellbereich	
	Code	Standard (ab Werk)	Einheit	min.	max.
Spannungskorrektur		0	V	9,9	9,9
Drahtgeschwindigkeit, absolut (Hauptprogramm P _A)		-	m/min	0,00	- 20,0
Gas-Sollwert (Option GFE)		8,5	l/min	3,0	30,0

8.1.2 MMA welding

Name	Darstellung			Einstellbereich	
	Code	Standard (ab Werk)	Einheit	min.	max.
Arcforce	ARC	0		-40	- 40

9 Appendix C

9.1 Searching for a dealer

Sales & service partners
www.ewm-group.com/en/specialist-dealers



"More than 400 EWM sales partners worldwide"