

Welding machine

Pico 350 cel puls
Pico 350 cel puls vrd (AUS)
Pico 350 cel puls vrd (RU)
Pico 350 cel puls 460V

099-002060-EW501

19.10.2015

**Register now
and benefit!**
**Jetzt Registrieren
und Profitieren!**

www.ewm-group.com



General instructions

CAUTION



Read the operating instructions!

The operating instructions provide an introduction to the safe use of the products.

- Read the operating instructions for all system components!
- Observe accident prevention regulations!
- Observe all local regulations!
- Confirm with a signature where appropriate.



In the event of queries on installation, commissioning, operation or special conditions at the installation site, or on usage, please contact your sales partner or our customer service department on +49 2680 181-0.

A list of authorised sales partners can be found at www.ewm-group.com.

Liability relating to the operation of this equipment is restricted solely to the function of the equipment. No other form of liability, regardless of type, shall be accepted. This exclusion of liability shall be deemed accepted by the user on commissioning the equipment.

The manufacturer is unable to monitor whether or not these instructions or the conditions and methods are observed during installation, operation, usage and maintenance of the equipment. An incorrectly performed installation can result in material damage and injure persons as a result. For this reason, we do not accept any responsibility or liability for losses, damages or costs arising from incorrect installation, improper operation or incorrect usage and maintenance or any actions connected to this in any way.

© EWM AG · Dr. Günter-Henle-Str. 8 · D-56271 Mündersbach, Germany

The copyright to this document remains the property of the manufacturer.

Reprinting, including extracts, only permitted with written approval.

The content of this document has been prepared and reviewed with all reasonable care. The information provided is subject to change, errors excepted.

1 Contents

1	Contents	3
2	Safety instructions	6
2.1	Notes on the use of these operating instructions	6
2.2	Explanation of icons	7
2.3	General	8
2.4	Transport and installation	12
2.4.1	Ambient conditions	13
2.4.1.1	In operation	13
2.4.1.2	Transport and storage	13
3	Intended use	14
3.1	Applications	14
3.1.1	MMA welding	14
3.1.1.1	Air arc gouging	14
3.1.2	TIG (Liftarc) welding	14
3.1.3	MIG/MAG standard welding	14
3.1.3.1	MIG/MAG welding – voltage-sensing	14
3.1.4	Voltage reduction device – VRD machine version	14
3.2	Documents which also apply	15
3.2.1	Warranty	15
3.2.2	Declaration of Conformity	15
3.2.3	Welding in environments with increased electrical hazards	15
3.2.4	Service documents (spare parts and circuit diagrams)	15
3.2.5	Calibration/Validation	15
4	Machine description – quick overview	16
4.1	Front view	16
4.2	Rear view	18
4.3	Machine control – Operating elements	20
5	Design and function	22
5.1	General	22
5.2	Machine cooling	23
5.3	Workpiece lead, general	23
5.4	Transport and installation	23
5.4.1	Adjusting the length of the carrying strap	24
5.4.2	Cable strap	24
5.4.3	Cable holder	25
5.4.3.1	Assembly	25
5.4.3.2	Application	25
5.4.4	Protective flap, welding machine control	26
5.4.4.1	Deinstallation/Installation	26
5.5	Welding data display	27
5.6	Mains connection	28
5.6.1	Mains configuration	28
5.7	MMA welding	29
5.7.1	Connecting the electrode holder and workpiece lead	29
5.7.2	Welding procedure and parameter selection	30
5.7.2.1	Arcforce (welding characteristics)	30
5.7.2.2	Hotstart current and Hotstart time	31
5.7.2.3	Antistick	31
5.7.3	MMA pulse welding in the vertical up position (PF)	32
5.7.4	MMA pulsed welding	33
5.7.5	Expert menu (MMA)	34
5.8	TIG welding	35
5.8.1	Shielding gas supply (shielding gas cylinder for welding machine)	35
5.8.1.1	Connection	36
5.8.2	Connecting a TIG welding torch with rotating gas valve	37
5.8.3	Welding procedure and parameter selection	38

5.8.4	TIG arc ignition	38
5.8.4.1	Liftarc ignition	38
5.8.4.2	TIG pulsed welding.....	39
5.8.5	Advanced settings	40
5.9	MIG/MAG welding	41
5.9.1	Connecting the intermediate hose package to the power source	41
5.9.2	Shielding gas supply (shielding gas cylinder for welding machine)	42
5.9.2.1	Setting the shielding gas quantity	43
5.9.3	MIG/MAG welding with constant voltage characteristics (CV)	44
5.9.3.1	Selection.....	44
5.9.3.2	Advanced settings	44
5.9.4	MIG/MAG welding with constant current characteristics (CC)	45
5.9.4.1	Selection.....	45
5.9.4.2	Advanced settings	45
5.10	MIG/MAG welding – voltage-sensing.....	46
5.10.1	General	46
5.10.2	Connection plan.....	46
5.10.2.1	Legend.....	46
5.10.3	Connecting the supply lines.....	47
5.11	Remote control.....	48
5.11.1	Foot-operated remote control RTF1 19POL.....	48
5.11.2	Manual remote control RT1 19POL.....	48
5.12	Voltage reducing device (VRD).....	48
5.13	Dirt filter.....	49
5.14	Machine configuration menu	50
6	Maintenance, care and disposal	52
6.1	General.....	52
6.2	Maintenance work, intervals	52
6.2.1	Daily maintenance tasks.....	52
6.2.1.1	Visual inspection	52
6.2.1.2	Functional test	52
6.2.2	Monthly maintenance tasks	52
6.2.2.1	Visual inspection	52
6.2.2.2	Functional test.....	52
6.2.3	Annual test (inspection and testing during operation)	53
6.3	Disposing of equipment.....	53
6.3.1	Manufacturer's declaration to the end user	53
6.4	Meeting the requirements of RoHS.....	53
7	Rectifying faults.....	54
7.1	Checklist for rectifying faults	54
7.2	Error messages (power source).....	55
7.3	Resetting welding parameters to the factory settings	56
8	Technical data.....	57
8.1	Pico 350 cel puls	57
8.2	Pico 350 cel puls 460V.....	58
9	Accessories	59
9.1	Remote controls and accessories.....	59
9.2	Options.....	59
9.3	General accessories	59
9.4	System components.....	59
9.4.1	Wire feed unit.....	59
10	Appendix A.....	60
10.1	Overview of EWM branches.....	60

2 Safety instructions

2.1 Notes on the use of these operating instructions

DANGER

Working or operating procedures which must be closely observed to prevent imminent serious and even fatal injuries.

- Safety notes include the "DANGER" keyword in the heading with a general warning symbol.
- The hazard is also highlighted using a symbol on the edge of the page.

WARNING

Working or operating procedures which must be closely observed to prevent serious and even fatal injuries.

- Safety notes include the "WARNING" keyword in the heading with a general warning symbol.
- The hazard is also highlighted using a symbol in the page margin.

CAUTION

Working or operating procedures which must be closely observed to prevent possible minor personal injury.

- The safety information includes the "CAUTION" keyword in its heading with a general warning symbol.
- The risk is explained using a symbol on the edge of the page.

CAUTION

Working and operating procedures which must be followed precisely to avoid damaging or destroying the product.















- The safety information includes the "CAUTION" keyword in its heading without a general warning symbol.
- The hazard is explained using a symbol at the edge of the page.

Special technical points which users must observe.

Instructions and lists detailing step-by-step actions for given situations can be recognised via bullet points, e.g.:

- Insert the welding current lead socket into the relevant socket and lock.

2.2 Explanation of icons

Symbol	Description
	Special technical points which users must observe.
	Correct
	Wrong
	Press
	Do not press
	Press and keep pressed
	Turn
	Switch
	Switch off machine
	Switch on machine
ENTER	enter the menu
NAVIGATION	Navigating in the menu
EXIT	Exit the menu
4 s 	Time display (example: wait 4s/press)
	Interruption in the menu display (other setting options possible)
	Tool not required/do not use
	Tool required/use

2.3 General

DANGER



Electromagnetic fields!

The power source may cause electrical or electromagnetic fields to be produced which could affect the correct functioning of electronic equipment such as IT or CNC devices, telecommunication lines, power cables, signal lines and pacemakers.

- Observe the maintenance instructions - See 6 Maintenance, care and disposal chapter!
- Unwind welding leads completely!
- Shield devices or equipment sensitive to radiation accordingly!
- The correct functioning of pacemakers may be affected (obtain advice from a doctor if necessary).



Do not carry out any unauthorised repairs or modifications!

To avoid injury and equipment damage, the unit must only be repaired or modified by specialist, skilled persons!

The warranty becomes null and void in the event of unauthorised interference.

- Appoint only skilled persons for repair work (trained service personnel)!



Electric shock!

Welding machines use high voltages which can result in potentially fatal electric shocks and burns on contact. Even low voltages can cause you to get a shock and lead to accidents.

- Do not touch any live parts in or on the machine!
- Connection cables and leads must be free of faults!
- Switching off alone is not sufficient!
- Place welding torch and stick electrode holder on an insulated surface!
- The unit should only be opened by specialist staff after the mains plug has been unplugged!
- Only wear dry protective clothing!
- Wait for 4 minutes until the capacitors have discharged!

WARNING



Risk of injury due to radiation or heat!

Arc radiation results in injury to skin and eyes.

Contact with hot workpieces and sparks results in burns.

- Use welding shield or welding helmet with the appropriate safety level (depending on the application)!
- Wear dry protective clothing (e.g. welding shield, gloves, etc.) according to the relevant regulations in the country in question!
- Protect persons not involved in the work against arc beams and the risk of glare using safety curtains!



Explosion risk!

Apparently harmless substances in closed containers may generate excessive pressure when heated.

- Move containers with inflammable or explosive liquids away from the working area!
- Never heat explosive liquids, dusts or gases by welding or cutting!

 **WARNING****Smoke and gases!**

Smoke and gases can lead to breathing difficulties and poisoning. In addition, solvent vapour (chlorinated hydrocarbon) may be converted into poisonous phosgene due to the ultraviolet radiation of the arc!

- Ensure that there is sufficient fresh air!
- Keep solvent vapour away from the arc beam field!
- Wear suitable breathing apparatus if appropriate!

**Fire hazard!**

Flames may arise as a result of the high temperatures, stray sparks, glowing-hot parts and hot slag produced during the welding process.

Stray welding currents can also result in flames forming!

- Check for fire hazards in the working area!
- Do not carry any easily flammable objects such as matches or lighters.
- Keep appropriate fire extinguishing equipment to hand in the working area!
- Thoroughly remove any residue of flammable substances from the workpiece before starting welding.
- Only continue work on welded workpieces once they have cooled down. Do not allow to come into contact with flammable material!
- Connect welding leads correctly!

**Risk of accidents due to non-compliance with the safety instructions!**

Non-compliance with the safety instructions can be fatal!

- Carefully read the safety instructions in this manual!
- Observe the accident prevention regulations and any regional regulations!
- Inform persons in the working area that they must comply with the regulations!

**Danger when coupling multiple power sources!**

Coupling multiple power sources in parallel or in series has to be carried out by qualified personnel and in accordance with the manufacturer's guidelines. Before bringing the power sources into service for arc welding operations, a test has to verify that they cannot exceed the maximum allowed open circuit voltage.

- Connection of the machine may be carried out by qualified personnel only!
- When decommissioning individual power sources, all mains and welding current leads have to be safely disconnected from the welding system as a whole. (Danger due to inverse voltages!)
- Do not couple welding machines with pole reversing switch (PWS series) or machines for AC welding, as a minor error in operation can cause the welding voltages to be combined.

 **CAUTION****Noise exposure!**

Noise exceeding 70 dBA can cause permanent hearing damage!

- Wear suitable ear protection!
- Persons located within the working area must wear suitable ear protection!

CAUTION



Obligations of the operator!

The respective national directives and laws must be observed for operation of the machine!

- National implementation of the framework directive (89/391/EWG), as well as the associated individual directives.
- In particular, directive (89/655/EWG), on the minimum regulations for safety and health protection when staff members use equipment during work.
- The regulations regarding work safety and accident prevention for the respective country.
- Setting up and operating the machine according to IEC 60974-9.
- Check at regular intervals that users are working in a safety-conscious way.
- Regular checks of the machine according to IEC 60974-4.



Damage due to the use of non-genuine parts!

The manufacturer's warranty becomes void if non-genuine parts are used!

- Only use system components and options (power sources, welding torches, electrode holders, remote controls, spare parts and replacement parts, etc.) from our range of products!
- Only insert and lock accessory components into the relevant connection socket when the machine is switched off.



Damage to the machine due to stray welding currents!

Stray welding currents can destroy protective earth conductors, damage equipment and electronic devices and cause overheating of components leading to fire.

- Make sure all welding leads are securely connected and check regularly.
- Always ensure a proper and secure electrical connection to the workpiece!
- Set up, attach or suspend all conductive power source components like casing, transport vehicle and crane frames so they are insulated!
- Do not place any other electronic devices such as drillers or angle grinders, etc., on the power source, transport vehicle or crane frames unless they are insulated!
- Always put welding torches and electrode holders on an insulated surface when they are not in use!



Mains connection

Requirements for connection to the public mains network

High-performance machines can influence the mains quality by taking current from the mains network. For some types of machines, connection restrictions or requirements relating to the maximum possible line impedance or the necessary minimum supply capacity at the interface with the public network (Point of Common Coupling, PCC) can therefore apply. In this respect, attention is also drawn to the machines' technical data. In this case, it is the responsibility of the operator, where necessary in consultation with the mains network operator, to ensure that the machine can be connected.

CAUTION**EMC Machine Classification**

In accordance with IEC 60974-10, welding machines are grouped in two electromagnetic compatibility classes - See 8 Technical data chapter:

Class A machines are not intended for use in residential areas where the power supply comes from the low-voltage public mains network. When ensuring the electromagnetic compatibility of class A machines, difficulties can arise in these areas due to interference not only in the supply lines but also in the form of radiated interference.

Class B machines fulfil the EMC requirements in industrial as well as residential areas, including residential areas connected to the low-voltage public mains network.

Setting up and operating

When operating arc welding systems, in some cases, electro-magnetic interference can occur although all of the welding machines comply with the emission limits specified in the standard. The user is responsible for any interference caused by welding.

In order to **evaluate** any possible problems with electromagnetic compatibility in the surrounding area, the user must consider the following: (see also EN 60974-10 Appendix A)

- Mains, control, signal and telecommunication lines
- Radios and televisions
- Computers and other control systems
- Safety equipment
- The health of neighbouring persons, especially if they have a pacemaker or wear a hearing aid
- Calibration and measuring equipment
- The immunity to interference of other equipment in the surrounding area
- The time of day at which the welding work must be carried out

Recommendations for reducing interference emission

- Mains connection, e.g. additional mains filter or shielding with a metal tube
- Maintenance of the arc welding equipment
- Welding leads should be as short as possible and run closely together along the ground
- Potential equalization
- Earthing of the workpiece. In cases where it is not possible to earth the workpiece directly, it should be connected by means of suitable capacitors.
- Shielding from other equipment in the surrounding area or the entire welding system

2.4 Transport and installation

WARNING



Incorrect handling of shielding gas cylinders!

Incorrect handling of shielding gas cylinders can result in serious and even fatal injury.

- Observe the instructions from the gas manufacturer and in any relevant regulations concerning the use of compressed air!
- Place shielding gas cylinders in the holders provided for them and secure with fixing devices.
- Avoid heating the shielding gas cylinder!



Risk of accident due to improper transport of machines that may not be lifted!

Do not lift or suspend the machine! The machine can fall down and cause injuries! The handles and brackets are suitable for transport by hand only!

- The machine may not be lifted by crane or suspended!

CAUTION



Risk of tipping!

There is a risk of the machine tipping over and injuring persons or being damaged itself during movement and set up. Tilt resistance is guaranteed up to an angle of 10° (according to IEC 60974-1).

- Set up and transport the machine on level, solid ground.
- Secure add-on parts using suitable equipment.



Damage due to supply lines not being disconnected!

During transport, supply lines which have not been disconnected (mains supply leads, control leads, etc.) may cause hazards such as connected equipment tipping over and injuring persons!

- Disconnect supply lines!

CAUTION



Equipment damage when not operated in an upright position!

The units are designed for operation in an upright position!

Operation in non-permissible positions can cause equipment damage.

- Only transport and operate in an upright position!

2.4.1 Ambient conditions

CAUTION



Installation location

The machine may only be placed and operated on a suitable, load-bearing and even surface (according to IP 34s in case of outside operation as well)!

- Ensure the machine is operated on an even, anti-slip floor and provide sufficient lighting of the work area.
- Safe operation of the machine must be guaranteed at all times!

CAUTION



Equipment damage due to dirt accumulation!

Unusually high quantities of dust, acid, corrosive gases or substances may damage the equipment.

- Avoid high volumes of smoke, vapour, oil vapour and grinding dust!
- Avoid ambient air containing salt (sea air)!



Non-permissible ambient conditions!

Insufficient ventilation results in a reduction in performance and equipment damage.

- Observe the ambient conditions!
- Keep the cooling air inlet and outlet clear!
- Observe the minimum distance of 0.5 m from obstacles!

2.4.1.1 In operation

Temperature range of the ambient air:

- -25 °C to +40 °C

Relative air humidity:

- Up to 50% at 40 °C
- Up to 90% at 20 °C

2.4.1.2 Transport and storage

Storage in an enclosed space, temperature range of the ambient air:

- -30 °C to +70 °C

Relative air humidity

- Up to 90% at 20 °C

3 Intended use

 **WARNING**



Hazards due to improper usage!
Hazards may arise for persons, animals and material objects if the equipment is not used correctly. No liability is accepted for any damages arising from improper usage!

- The equipment must only be used in line with proper usage and by trained or expert staff!
- Do not modify or convert the equipment improperly!

3.1 Applications

3.1.1 MMA welding

Manual arc welding or, for short, MMA welding. It is characterised by the fact that the arc burns between a melting electrode and the molten pool. There is no external protection; any protection against the atmosphere comes from the electrode.

3.1.1.1 Air arc gouging

During gouging, an arc burns between a carbon electrode and the workpiece, heating the workpiece until it is molten. At the same time, the molten metal is blown out with compressed air. Special electrode holders with a compressed-air connection and carbon electrodes are required for gouging.

3.1.2 TIG (Liftarc) welding

TIG welding procedure with arc striking by contact with the workpiece and subsequent removal of the electrode.

3.1.3 MIG/MAG standard welding



A suitable wire feed unit (system component) is required in order to operate the welding machine!

	Pico drive 4L	Pico drive 200C
Pico 350		☑

Metal arc welding using a wire electrode, where the arc and the weld pool are shielded from the atmosphere with inert (MIG) or active (MAG) gasses or gas mixtures.

3.1.3.1 MIG/MAG welding – voltage-sensing

This welding machine supports wire feeders with voltage detection (voltage-sensing). Voltage is supplied to these wire feeders solely by the welding voltage. The wire feeder has a lead to connect to the workpiece, to ensure voltage detection and supply.

No other control cables are required. When activated, the power source provides a permanent supply and welding voltage for the wire feeder.

3.1.4 Voltage reduction device – VRD machine version

To increase safety, particularly in hazardous environments (like shipbuilding, pipe construction or mining), the machine is equipped with the VRD (Voltage-reducing device) .

The VRD signal light is illuminated, when the voltage reducing device is operating without fault and the output voltage is reduced to a value specified in the relevant standard.

3.2 Documents which also apply

3.2.1 Warranty



For more information refer to the "Warranty registration" brochure supplied and our information regarding warranty, maintenance and testing at www.ewm-group.com!

3.2.2 Declaration of Conformity



The designated machine conforms to EC Directives and standards in terms of its design and construction:

- EC Low Voltage Directive (2006/95/EC),
- EC EMC Directive (2004/108/EC),

This declaration shall become null and void in the event of unauthorised modifications, improperly conducted repairs, non-observance of the deadlines for the repetition test and / or non-permitted conversion work not specifically authorised by the manufacturer.

The original copy of the declaration of conformity is enclosed with the unit.

3.2.3 Welding in environments with increased electrical hazards



In compliance with IEC / DIN EN 60974, VDE 0544 the machines can be used in environments with an increased electrical hazard.

3.2.4 Service documents (spare parts and circuit diagrams)



DANGER



Do not carry out any unauthorised repairs or modifications!

To avoid injury and equipment damage, the unit must only be repaired or modified by specialist, skilled persons!

The warranty becomes null and void in the event of unauthorised interference.

- Appoint only skilled persons for repair work (trained service personnel)!

Original copies of the circuit diagrams are enclosed with the unit.

Spare parts can be obtained from the relevant authorised dealer.

3.2.5 Calibration/Validation

We hereby confirm that this machine has been tested using calibrated measuring equipment, as stipulated in IEC/EN 60974, ISO/EN 17662, EN 50504, and complies with the admissible tolerances.

Recommended calibration interval: 12 months

4 Machine description – quick overview

4.1 Front view

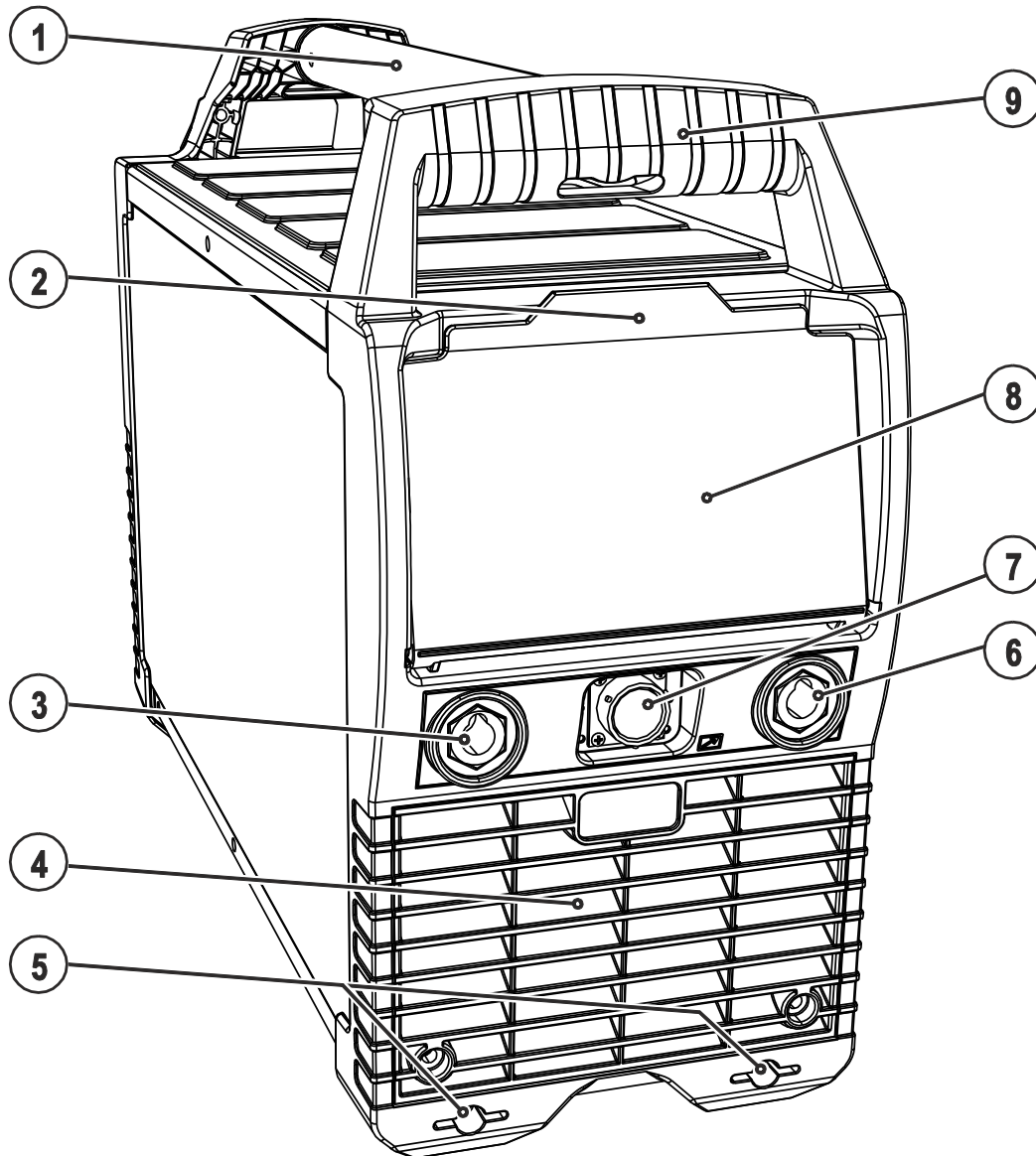





Figure 4-1

Item	Symbol	Description
1		Transport bar
2		Protective cap
3		Connection socket, “+” welding current How to connect the accessories depends on the welding procedure. Please observe the connection description for the corresponding welding procedure.
4		Cooling air inlet Dirt filter can be retrofitted
5		Machine feet
6		Connection socket, “-” welding current How to connect the accessories depends on the welding procedure. Please observe the connection description for the corresponding welding procedure.
7		19-pole connection socket Control cable for remote control and/or wire feeder
8		Machine control- See 4.3 Machine control – Operating elements chapter
9		Carrying handle

4.2 Rear view

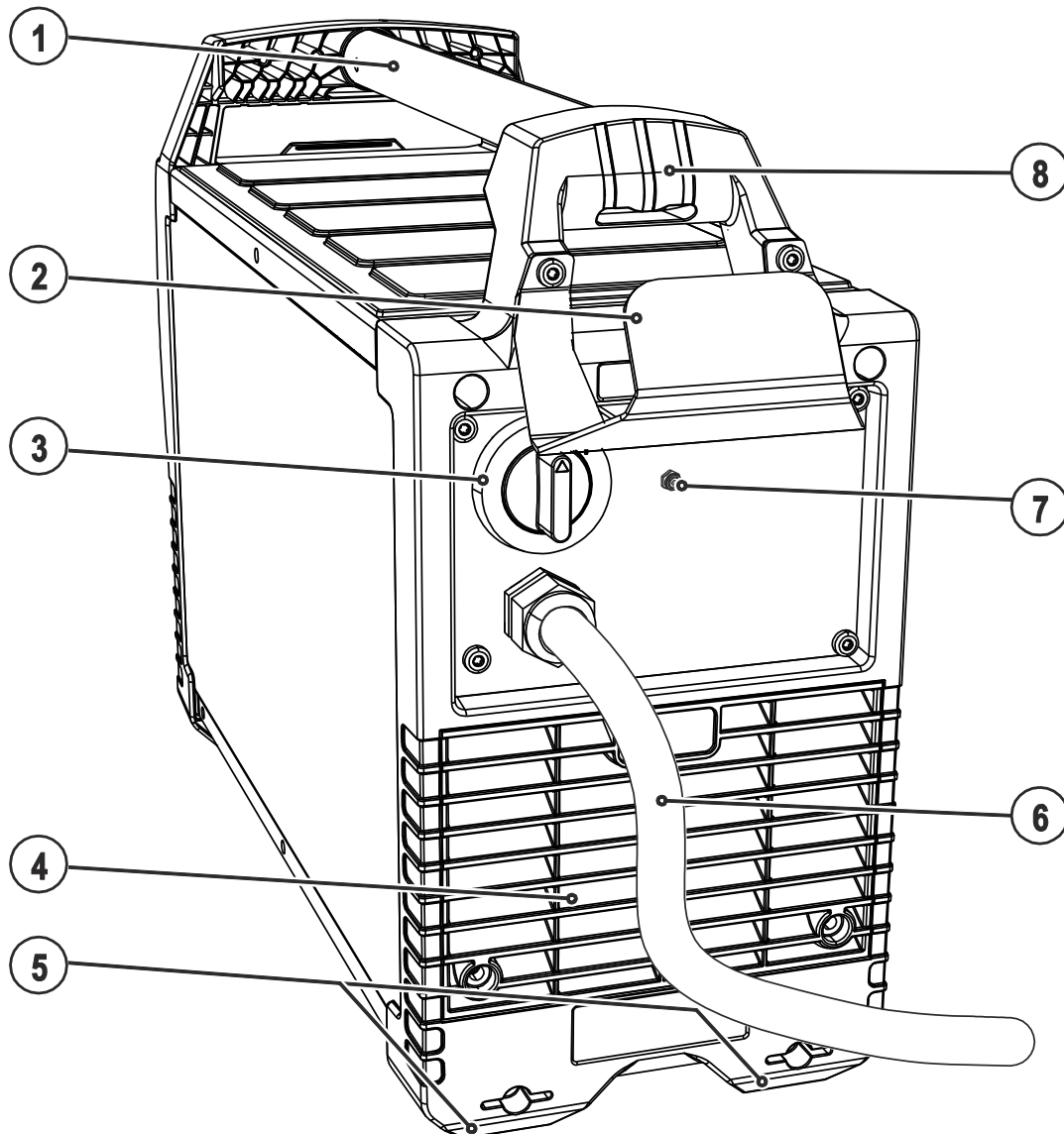



Figure 4-2

Item	Symbol	Description
1		Transport bar
2		Cable holder
3		Main switch, machine on/off
4		Cooling air outlet
5		Machine feet
6		Mains connection cable - See 5.6 Mains connection chapter
7		Key button, automatic cutout Wire feed motor supply voltage fuse press to reset a triggered fuse
8		Carrying handle

4.3 Machine control – Operating elements

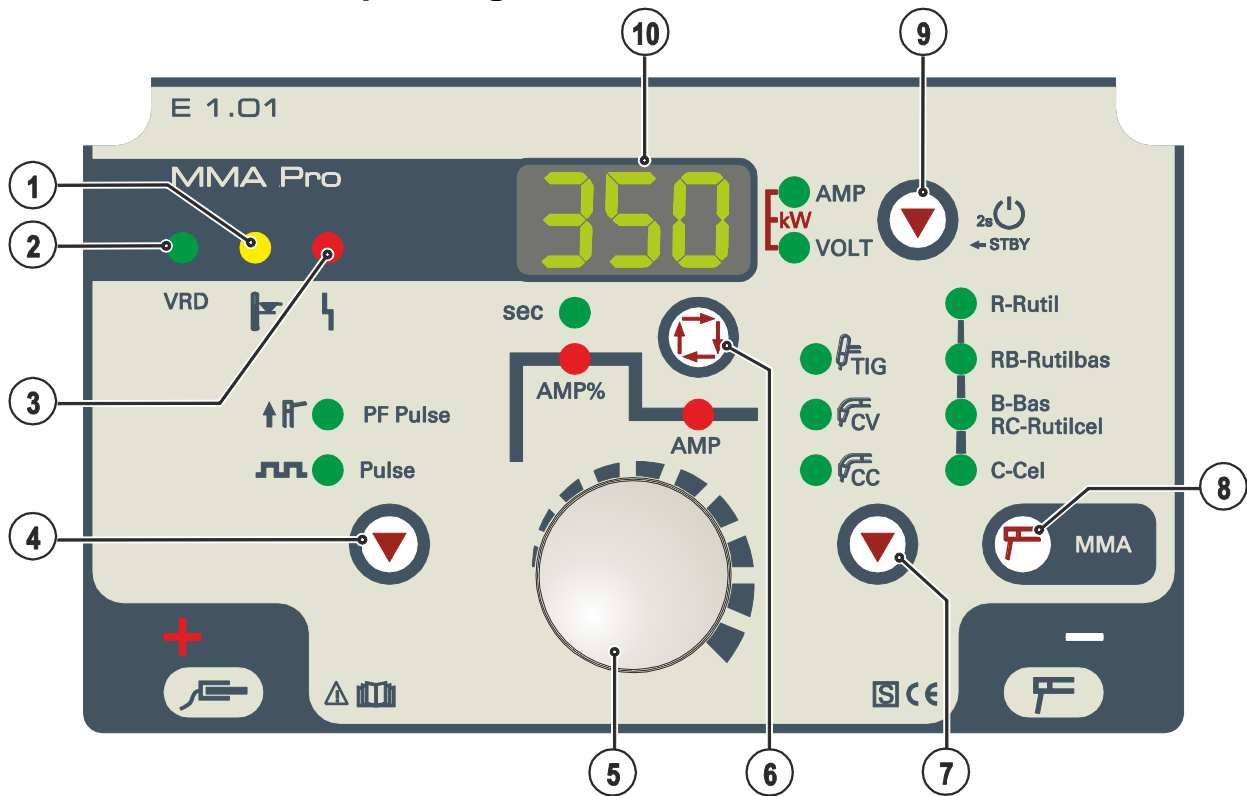





Figure 4-3

Item	Symbol	Description
1		Excess temperature signal light In case of excess temperature, temperature monitors de-activate the power unit, and the excess temperature control lamp comes on. Once the machine has cooled down, welding can continue without any further measures.
2	VRD	Voltage reduction device (VRD) signal light The VRD signal light is illuminated when the voltage reduction device is operating without fault and the output voltage is reduced to a value specified in the relevant standard (see technical data). The voltage reduction device is only active on VRD machine versions.
3		Collective interference signal light For error messages, - See 7 Rectifying faults chapter
4		Pulsing push-button ↑fl PF pulsing (MMA) Pulsing (MMA/TIG)
5		Welding parameter setting rotary transducer Setting of welding current and other welding parameter and their values
6		Select welding parameters button This button is used to select the welding parameters depending on the welding process and operating mode used.
7		Welding procedure selection push-button TIG TIG welding CV MIG/MAG welding with constant voltage characteristics Default characteristics "CV constant voltage" for nearly all MIG/MAG processes CC MIG/MAG welding with constant current characteristics Used for special wires (flux cored wires), which, according to the manufacturer, are to be welded using "CC constant current"

Item	Symbol	Description
8		<p>Welding procedure/MMA characteristics selection push-button Select MMA welding procedure and electrode type</p> <p>R Electrode type rutile RB Electrode type rutile-basic B / RC Electrode type basic/rutile-cellulose C Electrode type cellulose</p>
9		<p>Display/Power-saving mode switching push-button</p> <p>AMP Welding current display VOLT Welding voltage display kW Welding performance display (both signal lights are illuminated) STBY Press for 2 s to put machine into power-saving mode. To reactivate, activate one of the operating elements.</p>
10		<p>Welding data display (3-digit) Displays the welding parameters and the corresponding values</p>

5 Design and function

5.1 General

WARNING



Risk of injury from electric shock!

Contact with live parts, e.g. welding current sockets, is potentially fatal!

- Follow safety instructions on the opening pages of the operating instructions.
- Commissioning may only be carried out by persons who have the relevant expertise of working with arc welding machines!
- Connection and welding leads (e.g. electrode holder, welding torch, workpiece lead, interfaces) may only be connected when the machine is switched off!

CAUTION



Insulate the arc welder from welding voltage!

Not all active parts of the welding current circuit can be shielded from direct contact. To avoid any associated risks it is vital for the welder to adhere to the relevant safety regulations. Even low voltages can cause a shock and lead to accidents.

- Wear dry and undamaged protective clothing (shoes with rubber soles/welder's gloves made from leather without any studs or braces)!
- Avoid direct contact with non-insulated connection sockets or connectors!
- Always place torches and electrode holders on an insulated surface!



Risk of burns on the welding current connection!

If the welding current connections are not locked, connections and leads heat up and can cause burns, if touched!

- Check the welding current connections every day and lock by turning in clockwise direction, if necessary.

CAUTION



Damage due to incorrect connection!

Accessory components and the power source itself can be damaged by incorrect connection!

- Only insert and lock accessory components into the relevant connection socket when the machine is switched off.
- Comprehensive descriptions can be found in the operating instructions for the relevant accessory components.
- Accessory components are detected automatically after the power source is switched on.



Using protective dust caps!

Protective dust caps protect the connection sockets and therefore the machine against dirt and damage.

- The protective dust cap must be fitted if there is no accessory component being operated on that connection.
- The cap must be replaced if faulty or if lost!

5.2 Machine cooling

To obtain an optimal duty cycle from the power components, the following precautions should be observed:

- Ensure that the working area is adequately ventilated.
- Do not obstruct the air inlets and outlets of the machine.
- Do not allow metal parts, dust or other objects to get into the machine.

5.3 Workpiece lead, general

CAUTION



Risk of burns due to incorrect connection of the workpiece lead!

Paint, rust and dirt on the connection restrict the power flow and may lead to stray welding currents.

Stray welding currents may cause fires and injuries!

- Clean the connections!
- Fix the workpiece lead securely!
- Do not use structural parts of the workpiece as a return lead for the welding current!
- Take care to ensure faultless power connections!

5.4 Transport and installation

WARNING



Risk of accident due to improper transport of machines that may not be lifted!

Do not lift or suspend the machine! The machine can fall down and cause injuries! The handles and brackets are suitable for transport by hand only!

- The machine may not be lifted by crane or suspended!

CAUTION



Installation location

The machine may only be placed and operated on a suitable, load-bearing and even surface (according to IP 34s in case of outside operation as well)!

- Ensure the machine is operated on an even, anti-slip floor and provide sufficient lighting of the work area.
- Safe operation of the machine must be guaranteed at all times!

5.4.1 Adjusting the length of the carrying strap

 To demonstrate adjustment, lengthening the strap is shown in the figure. To shorten, the strap's loops must be inched in the opposite direction.

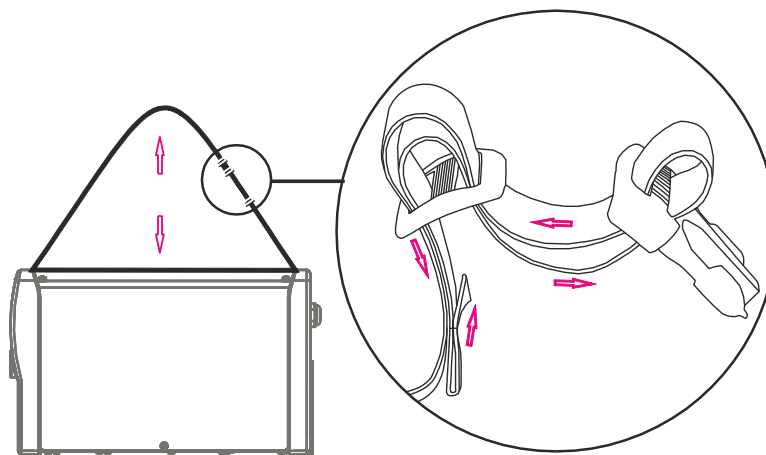

Figure 5-1

5.4.2 Cable strap

In the delivery state, the machine has a cable strap for easy and orderly transport of earth lead, welding torch, electrode holder etc. The following figure shows the fastened strap and how the components can be secured.

The machine itself may not be transported with this cable strap!



Figure 5-2

5.4.3 Cable holder

The machine is supplied with a cable holder with mounting material. This cable holder can be used to coil and conveniently transport the mains cable. Install the cable holder as shown in the figure.

5.4.3.1 Assembly

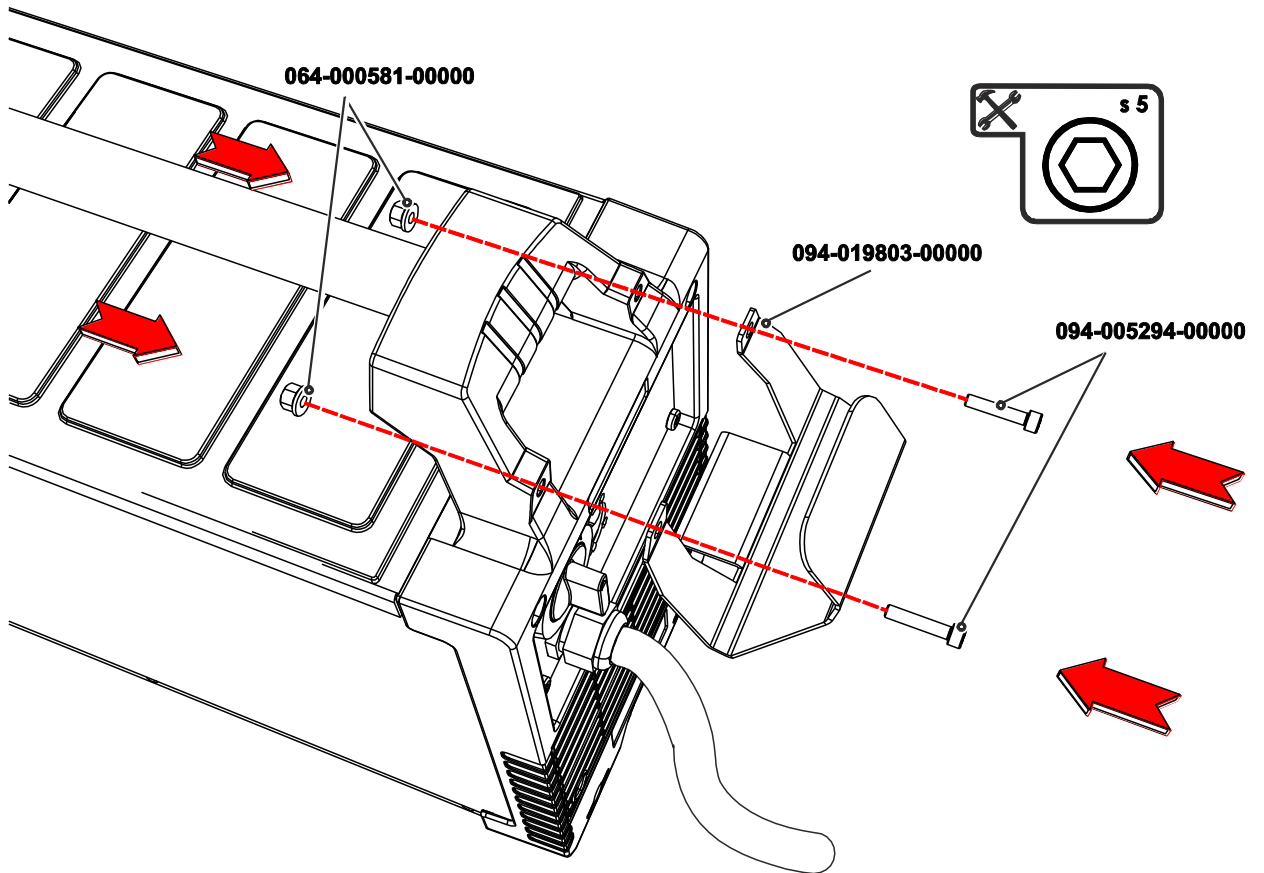

Figure 5-3

5.4.3.2 Application



Figure 5-4

5.4.4 Protective flap, welding machine control

5.4.4.1 Deinstallation/Installation

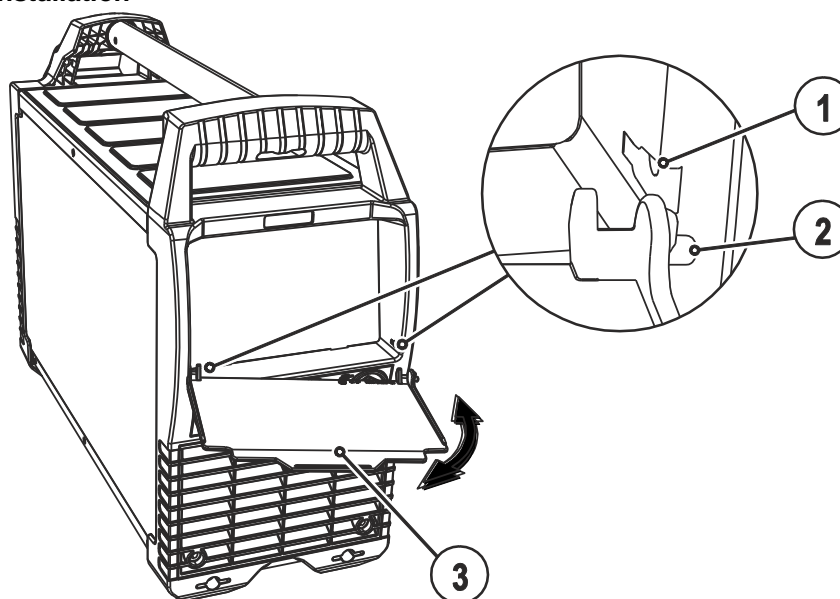

Figure 5-5

Item	Symbol	Description
1		Seating hole for mounting nipple
2		Mounting nipple, protective cap
3		Protective cap

- Remove the protective cap by gently pressing from the side while simultaneously pulling. To attach, insert and snap into place.

5.5 Welding data display

All relevant welding parameters with their values are shown depending on the welding procedure selected and the associated functions. Machine parameters and error codes are shown as well in a unique manner. The meaning of the parameters and values shown is explained in the relevant chapter for the function.

Next to the display is the Display/Power-saving mode switching push-button. Each time the push-button is pressed the display switches between the desired parameters.

Depending on the process, the parameters are shown as nominal values (before welding), actual values (during welding) or hold values (after welding):

MMA welding, TIG welding and MIG/MAG welding with constant current (CC):

	Nominal values	Actual values	Hold values (5 s)
Welding current (AMP)	<input checked="" type="checkbox"/>	<input type="checkbox"/> / <input checked="" type="checkbox"/> ^[1]	<input type="checkbox"/> / <input checked="" type="checkbox"/> ^[1]
Welding voltage (VOLT)	<input type="checkbox"/>	<input checked="" type="checkbox"/>	<input checked="" type="checkbox"/>
Welding performance (kW)	<input type="checkbox"/>	<input checked="" type="checkbox"/>	<input checked="" type="checkbox"/>
Open circuit voltage	<input checked="" type="checkbox"/>	<input type="checkbox"/>	<input type="checkbox"/>

By turning the rotary transducer for the welding parameter settings the display automatically switches to the welding current display.

MIG/MAG welding with constant voltage (CV):

	Nominal values	Actual values	Hold values (5 s)
Welding current (AMP)	<input checked="" type="checkbox"/>	<input checked="" type="checkbox"/>	<input checked="" type="checkbox"/>
Welding voltage (VOLT)	<input checked="" type="checkbox"/>	<input checked="" type="checkbox"/>	<input checked="" type="checkbox"/>
Welding performance (kW)	<input checked="" type="checkbox"/>	<input checked="" type="checkbox"/>	<input checked="" type="checkbox"/>

By turning the rotary transducer for the welding parameter settings the display automatically switches to the welding voltage display.

^[1] optionally adjustable – - See 5.14 Machine configuration menu chapter

5.6 Mains connection

⚠ DANGER



Hazard caused by improper mains connection!

An improper mains connection can cause injuries or damage property!

- Only use machine with a plug socket that has a correctly fitted protective conductor.
- If a mains plug must be fitted, this may only be carried out by an electrician in accordance with the relevant national provisions or regulations!
- Mains plug, socket and lead must be checked regularly by an electrician!
- When operating the generator always ensure it is earthed as stated in the operating instructions. The resulting network has to be suitable for operating devices according to protection class 1.

5.6.1 Mains configuration



The machine may be connected to:

- a three-phase system with four conductors and an earthed neutral conductor
- a three-phase system with three conductors of which any one can be earthed, e.g. the outer conductor

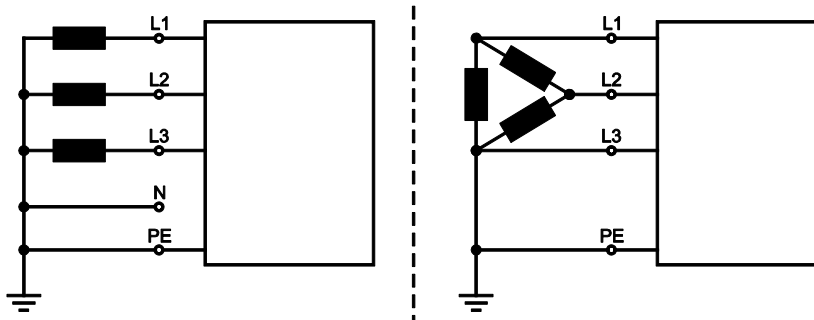

Figure 5-6

Legend

Item	Designation	Colour code
L1	Outer conductor 1	brown
L2	Outer conductor 2	black
L3	Outer conductor 3	grey
N	Neutral conductor	blue
PE	Protective conductor	green-yellow

CAUTION



Operating voltage - mains voltage!

The operating voltage shown on the rating plate must be consistent with the mains voltage, in order to avoid damage to the machine!

- - See 8 Technical data chapter!

- Insert mains plug of the switched-off machine into the appropriate socket.

5.7 MMA welding

⚠ CAUTION



Risk of being crushed or burnt.

When replacing spent or new stick electrodes

- Switch off machine at the main switch
- Wear appropriate safety gloves
- Use insulated tongs to remove spent stick electrodes or to move welded workpieces and
- Always put the electrode holder down on an insulated surface.

5.7.1 Connecting the electrode holder and workpiece lead



Polarity depends on the instructions from the electrode manufacturer given on the electrode packaging.

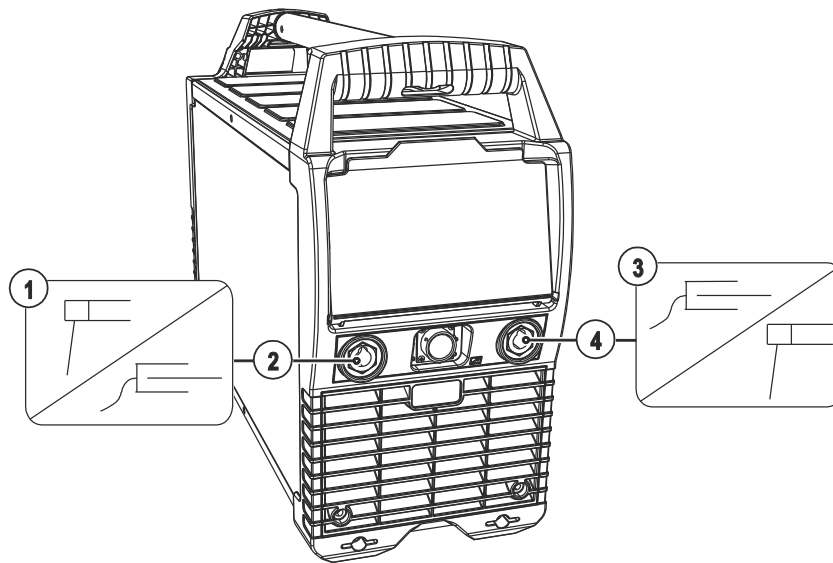

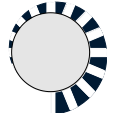



Figure 5-7

Item	Symbol	Description
1		Electrode holder
2		Connection socket for "+" welding current Electrode holder or workpiece lead connection
3		Workpiece
4		Connection socket, "-" welding current Workpiece lead or electrode holder connection

- Insert cable plug of the electrode holder into either the "+" or "-" welding current connection socket and lock by turning to the right.
- Insert cable plug of the workpiece lead into either the "+" or "-" welding current connection socket and lock by turning to the right.

5.7.2 Welding procedure and parameter selection

Operating element	Action	Result
<ul style="list-style-type: none"> ● R-Rutil ● RB-Rutilbas ● B-Bas ● RC-Rutilcel ● C-Cel 		Select MMA welding procedure and electrode type R Electrode type rutile RB Electrode type rutile-basic B / RC Electrode type basic/rutile-cellulose C Electrode type cellulose
		Set welding current

5.7.2.1 Arcforce (welding characteristics)

During the welding process, arcforce prevents the electrode sticking in the weld pool with increases in current. This makes it easier to weld large-drop melting electrode types at low current strengths with a short arc in particular.

 **The electrode characteristics you can select at the machine control are guiding values. Each characteristics can be optimised according to electrode type and the related welding properties. - See 5.7.5 Expert menu (MMA) chapter.**

Electrode type allocation

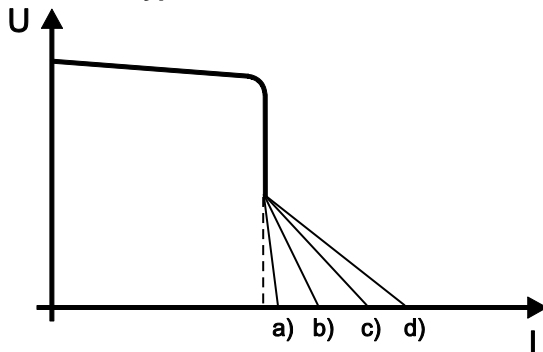

Item	Electrode type	
a)	R	rutile
b)	RB	rutile basic
c)	B/RC	basic and rutile/cellulose
d)	C	cellulose

Figure 5-8

5.7.2.2 Hotstart current and Hotstart time

The hotstart device uses an increased ignition current to improve arc ignition. The parameters for the hotstart current and time can be adjusted individually.

When the stick electrode has been struck, the arc ignites at the adjusted hotstart current AMP% (factory setting: 120 % of main current) and welds at this current until the hotstart time in seconds has elapsed (factory setting: 1 second). The hotstart current then reduces to the main current set.

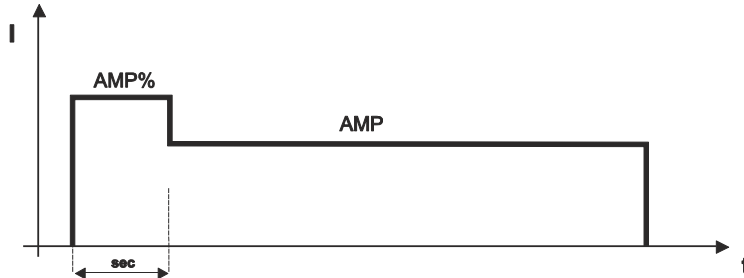

Symbol	Meaning
AMP	Main current
AMP%	Hotstart current
sec	Hotstart time

Figure 5-9

Hotstart current

Control element	Action	Result
	n x	Signal light AMP% lights up
		Hotstart current is set as a percentage of the main current (50 % to 200 %)

Hotstart time

Control element	Action	Result
	n x	Signal light sec lights up
		Hotstart time is set (0.1 s to 20 s)

After a waiting time of approx 5 s, the display changes back to the main current set and the signal light AMP comes on.

5.7.2.3 Antistick

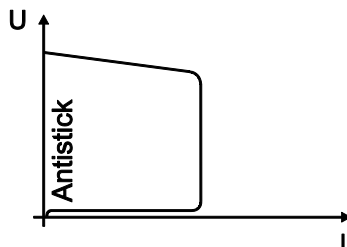

Anti-stick prevents the electrode from annealing.

If the electrode sticks in spite of the Arcforce device, the machine automatically switches over to the minimum current within about 1 second to prevent the electrode from overheating. Check the welding current setting and correct according to the welding task!

Figure 5-10

5.7.3 MMA pulse welding in the vertical up position (PF)

Welding characteristics:

- Especially suitable for root welding
- Fine-flaked weld surface with a TIG look for final passes
- Less finishing work thanks to less spatter
- Highly suitable for difficult electrodes
- Outstanding gap bridging with no sagging of the root side
- Less distortion thanks to controlled heat input

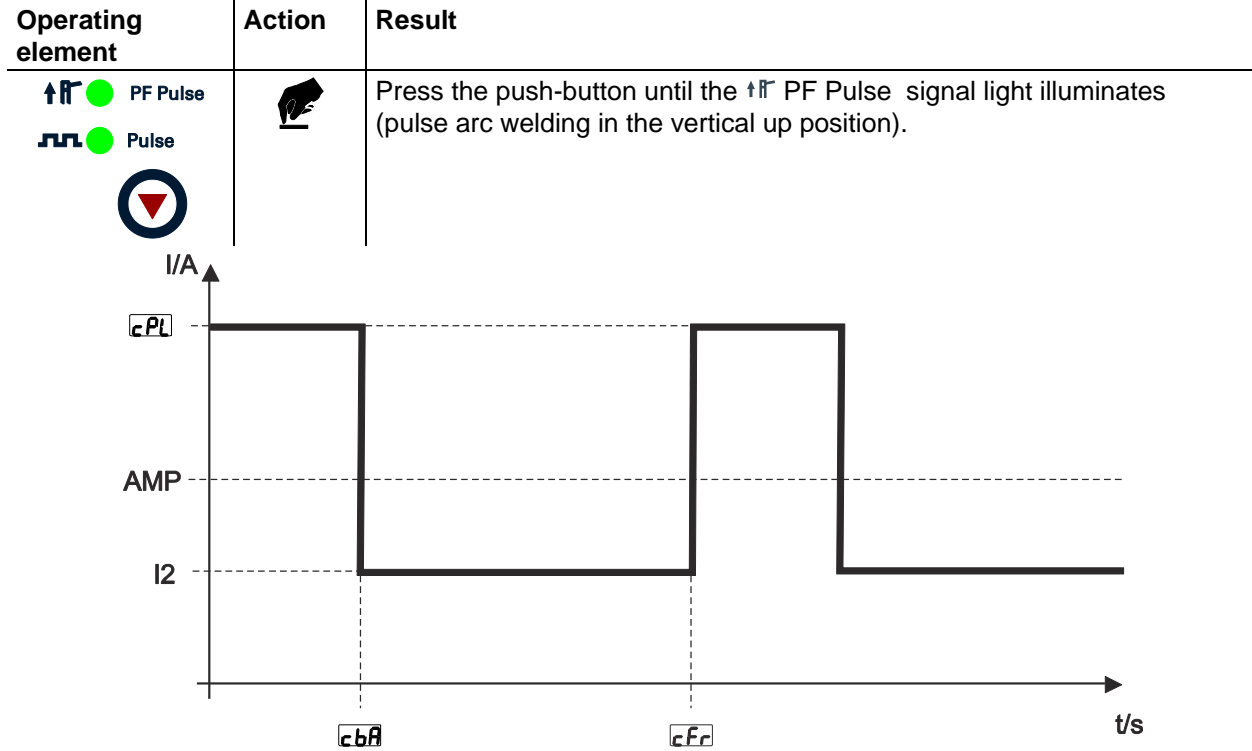

Figure 5-11

AMP = main current

cPL = pulse current correction

I2 = pulse pause current

cFr = frequency correction

cbA = balance correction

The pulse pause current (I2) requires no setting. This value is calculated by the machine control, so that the welding current average value always corresponds to the main current selected.

For parameter setting, - See 5.7.5 Expert menu (MMA) chapter.

5.7.4 MMA pulsed welding

Operating element	Action	Result
PF Pulse Pulse 		Press the push-button until the Pulse (pulse arc welding) signal light illuminates.

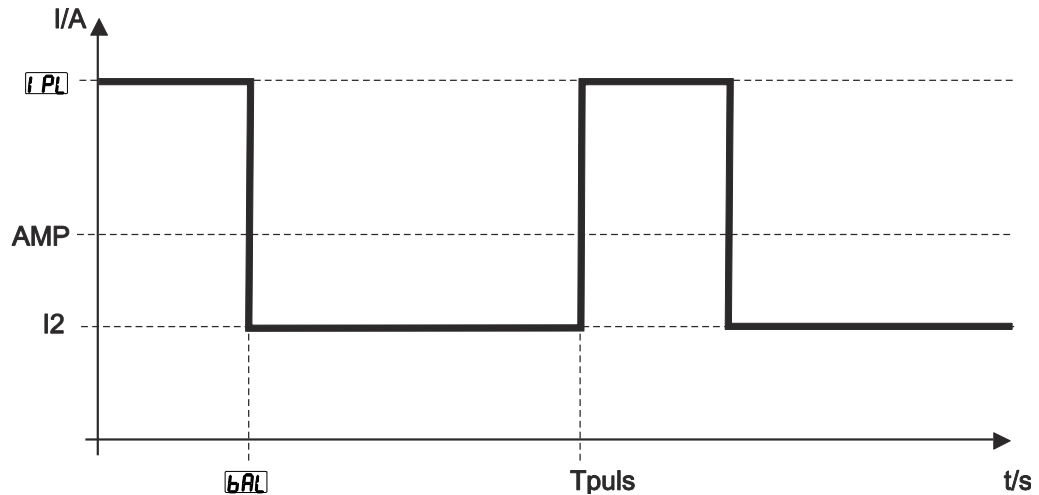

Figure 5-12

AMP = Main current; e.g. 100 A

IPL = Pulse current = IP1 x AMP; e.g. 170% x 100 A = 170 A

I2 = Pulse pause current

Tpuls = Duration of one pulse cycle = 1/FrE; e.g. 1/1 Hz = 1 s

bAL = Balance = bAL x Tpuls; e.g. 30% x 1 s = 0.3 s

- The pulse pause current (I2) requires no setting. This value is calculated by the machine control, so that the welding current average value always corresponds to the main current selected.**
- For parameter setting, - See 5.7.5 Expert menu (MMA) chapter.**

5.7.5 Expert menu (MMA)

- To enable the greatest possible breadth of applications, the following parameters can be adjusted or optimised for the welding task.**
- To change the advanced setting parameters, hold down the "Welding parameters" button for 2 seconds after selecting the welding process.**
The following diagram shows the setting options.

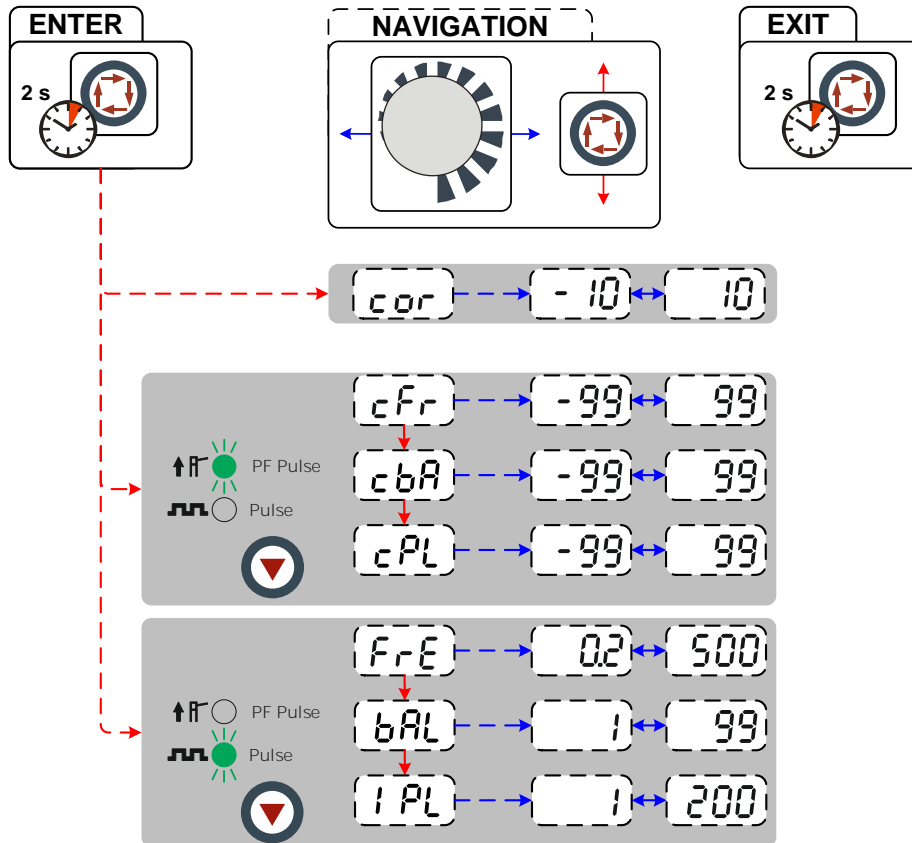

Figure 5-13

Display	Setting/selection
	Arcforce correction (setting -10 to 10, factory setting 0) <ul style="list-style-type: none"> • Increase value > harder arc • Decrease value > softer arc
	Frequency correction (setting: -99% to 99%, ex works: 0%) Frequency correction of the PF Pulse parameter in per cent.
	Balance correction (setting: -99% to 99%, ex works: 0%) Balance correction of the PF Pulse parameter in per cent
	Pulse current correction (setting: -99% to 99%, ex works: 0%) Pulse current correction of the PF Pulse parameter in per cent.
	Frequency, MMA pulsed welding Setting range: 0.2 Hz to 500 Hz (ex works: 5.0 Hz)
	Balance Percentage of time from pulse cycle T _{puls} for pulse current IP1 Setting range 1%–99%
	Pulse current Setting range 1%–200%

5.8 TIG welding

5.8.1 Shielding gas supply (shielding gas cylinder for welding machine)

WARNING



**Risk of injury due to improper handling of shielding gas cylinders!
Improper handling and insufficient securing of shielding gas cylinders can cause serious injuries!**

- The fastening elements must tightly enclose the shielding gas cylinder!
- Attach the fastening elements within the upper half of the shielding gas cylinder!
- Do not attach any element to the shielding gas cylinder valve!
- Observe the instructions from the gas manufacturer and any relevant regulations concerning the use of compressed air!
- Avoid heating the shielding gas cylinder!

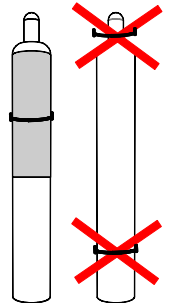

CAUTION



Faults in the shielding gas supply.

An unhindered shielding gas supply from the shielding gas cylinder to the welding torch is a fundamental requirement for optimum welding results. In addition, a blocked shielding gas supply may result in the welding torch being destroyed.

- Always re-fit the yellow protective cap when not using the shielding gas connection.
- All shielding gas connections must be gas tight.



Before connecting the pressure regulator to the gas cylinder, open the cylinder valve briefly to expel any dirt.

5.8.1.1 Connection

- Place the shielding gas cylinder into the relevant cylinder bracket.
- Secure the shielding gas cylinder using a securing chain.

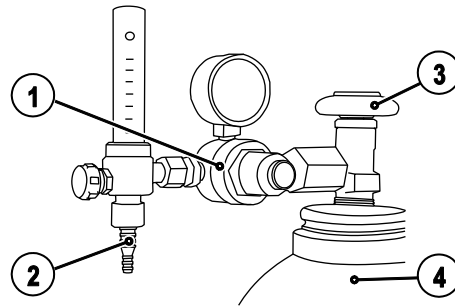

Figure 5-14

Item	Symbol	Description
1		Pressure regulator
2		Output side of the pressure regulator
3		Cylinder valve
4		Shielding gas cylinder

- Tighten the pressure regulator screw connection on the gas bottle valve to be gas-tight.

5.8.2 Connecting a TIG welding torch with rotating gas valve

Prepare welding torch according to the welding task in hand (see operating instructions for the torch).

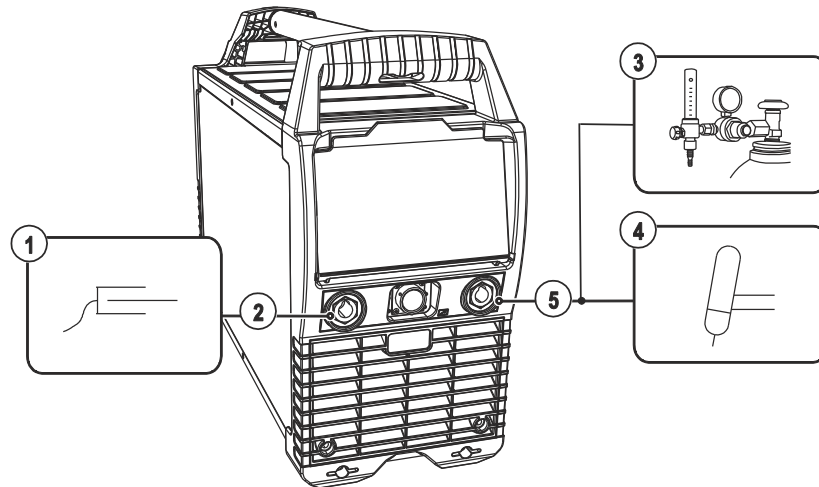

Figure 5-15

Item	Symbol	Description
1		Workpiece
2		Connection socket for "+" welding current Workpiece lead connection
3		Output side of the pressure regulator
4		Welding torch
5		Connection socket, "-" welding current Welding current lead connection for TIG welding torch





- Insert the welding current plug on the welding torch into the welding current connection socket and lock by turning to the right.
- Insert the cable plug on the work piece lead into the "+" welding current connection socket and lock by turning to the right.
- Screw the shielding gas connection of the welding torch to the pressure reducer on the shielding gas cylinder.
- Slowly open the gas cylinder valve.

Prior to every welding task the rotary valve has to be opened and, after welding, be closed again.

- Open the welding torch rotary valve.
- Set the required shielding gas quantity at the pressure regulator.

Rule of thumb for the gas flow rate:
Diameter of gas nozzle in mm corresponds to gas flow in l/min.
Example: 7mm gas nozzle corresponds to 7l/min gas flow.

5.8.3 Welding procedure and parameter selection

Operating element	Action	Result
<ul style="list-style-type: none"> ● TIG ● CV ● CC 		Press the welding procedure selection push-button until the TIG signal light illuminates.
		Set main current

5.8.4 TIG arc ignition

5.8.4.1 Liftarc ignition

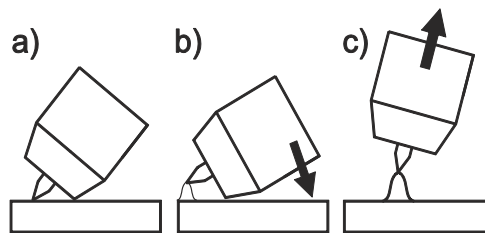

Figure 5-16

The arc is ignited on contact with the workpiece:

- a) Carefully place the torch gas nozzle and tungsten electrode tip onto the workpiece (liftarc current flowing, regardless of the main current set).
- b) Incline the torch towards the torch gas nozzle until there is a gap of approx. 2-3mm between the tip of the electrode and the workpiece (arc ignites, current increases to the main current set).
- c) Lift off the torch and swivel to the normal position.

Ending the welding process: Remove the torch from the workpiece until the arc goes out.

5.8.4.2 TIG pulsed welding

Operating element	Action	Result
PF Pulse Pulse 		Press the push-button until the Pulse (pulse arc welding) signal light illuminates.

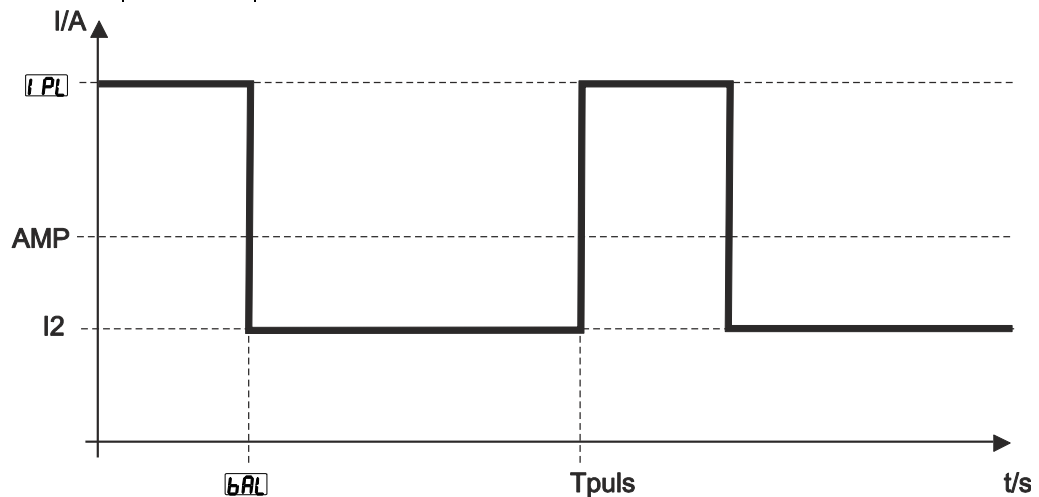

Figure 5-17

AMP = Main current; e.g. 100 A

IPL = Pulse current = IP1 x AMP; e.g. 170% x 100 A = 170 A

I2 = Pulse pause current

Tpuls = Duration of one pulse cycle = 1/FrE; e.g. 1/1 Hz = 1 s

bAL = Balance = bAL x Tpuls; e.g. 30% x 1 s = 0.3 s

The pulse pause current (I2) requires no setting. This value is calculated by the machine control, so that the welding current average value always corresponds to the main current selected.

For parameter setting, - See 5.8.5 Advanced settings chapter.

5.8.5 Advanced settings

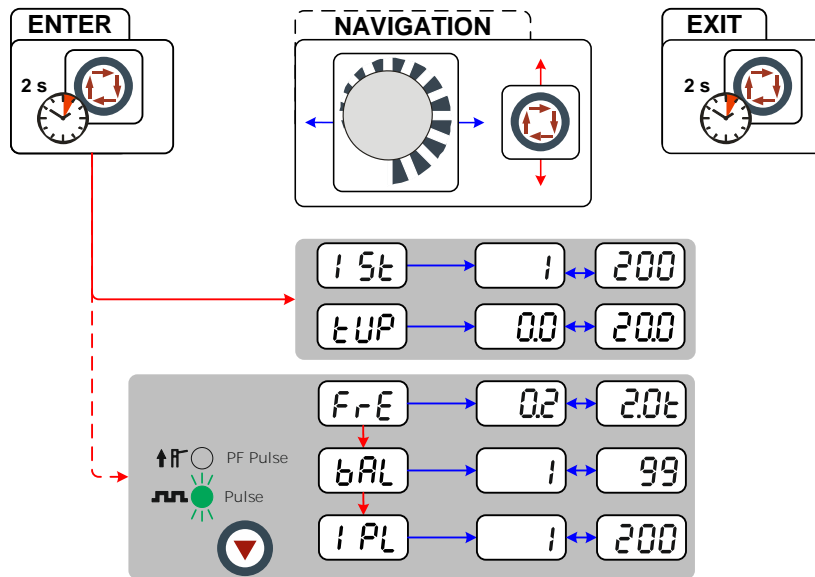

Figure 5-18

Display	Setting/selection
ISt	Ignition current Setting: 1% to 200% (20% ex works, dependent on main current)
tUP	Up-slope time 0.0 s to 20.0 s (1.0 s ex works, 0.1 s increments)
FrE	Pulsed TIG welding frequency Setting range: 0.2 Hz–2.0 kHz
bAL	Balance Percentage of time from pulse cycle T_{puls} for pulse current IP1 Setting range 1%–99%
I PL	Pulse current Setting range 1%–200%

5.9 MIG/MAG welding

5.9.1 Connecting the intermediate hose package to the power source



Some wire electrodes (e.g. self-shielding cored wire) are welded using negative polarity. In this case, the welding current lead should be connected to the "-" welding current socket, and the workpiece lead should be connected to the "+" welding current socket. Observe the information from the electrode manufacturer!

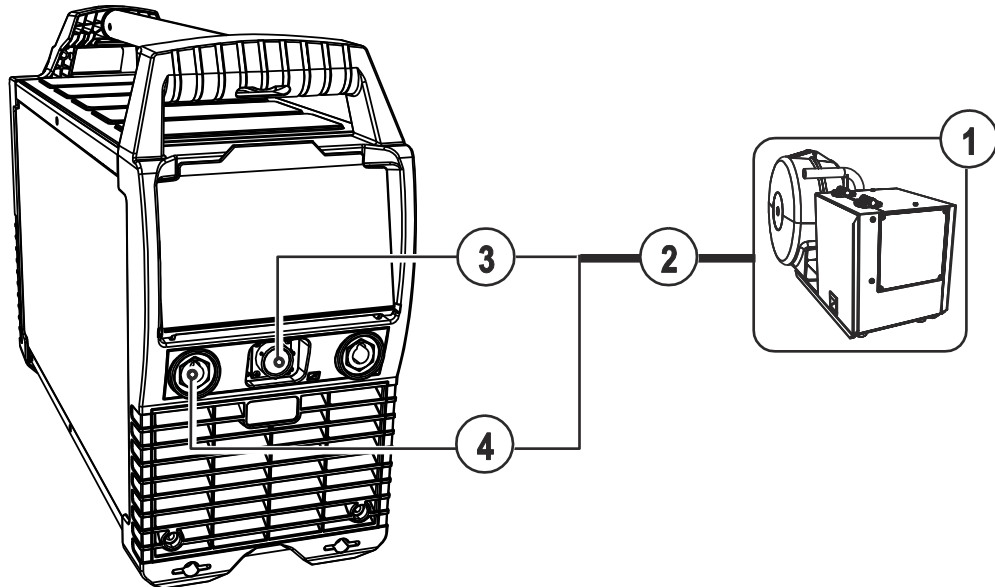

Figure 5-19

Item	Symbol	Description
1		Wire feed unit
2		Intermediate hose package
3		19-pole connection socket (analogue) Wire feed unit control lead connection
4		Connection socket, welding current "+" Welding current connection on wire feed unit

- Insert the plug on the welding current lead into the welding current connection socket "+" and lock.
- Insert cable plug on the control lead into the 19-pole connection socket and secure with crown nut (the plug can only be inserted into the connection socket in one position).

5.9.2 Shielding gas supply (shielding gas cylinder for welding machine)

⚠ WARNING

⚠ Risk of injury due to improper handling of shielding gas cylinders! Improper handling and insufficient securing of shielding gas cylinders can cause serious injuries!

- The fastening elements must tightly enclose the shielding gas cylinder!
- Attach the fastening elements within the upper half of the shielding gas cylinder!
- Do not attach any element to the shielding gas cylinder valve!
- Observe the instructions from the gas manufacturer and any relevant regulations concerning the use of compressed air!
- Avoid heating the shielding gas cylinder!

⚠ CAUTION

⚠ Faults in the shielding gas supply.
An unhindered shielding gas supply from the shielding gas cylinder to the welding torch is a fundamental requirement for optimum welding results. In addition, a blocked shielding gas supply may result in the welding torch being destroyed.

- Always re-fit the yellow protective cap when not using the shielding gas connection.
- All shielding gas connections must be gas tight.

Before connecting the pressure regulator to the gas cylinder, open the cylinder valve briefly to expel any dirt.

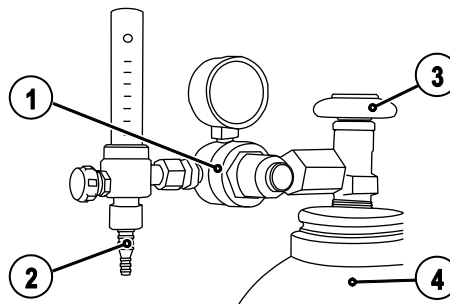

Figure 5-20

Item	Symbol	Description
1		Pressure regulator
2		Shielding gas cylinder
3		Output side of the pressure regulator
4		Cylinder valve

- Place the shielding gas cylinder into the relevant cylinder bracket.
- Secure the shielding gas cylinder using a securing chain.
- Tighten the pressure regulator screw connection on the gas bottle valve to be gas-tight.
- Screw the gas hose (intermediate hose package) to the pressure regulator ensuring that it is gas tight.

5.9.2.1 Setting the shielding gas quantity

Welding process	Recommended shielding gas quantity
MAG welding	Wire diameter x 11.5 = l/min
MIG brazing	Wire diameter x 11.5 = l/min
MIG welding (aluminium)	Wire diameter x 13.5 = l/min (100 % argon)

Helium-rich gas mixtures require a higher gas volume!

The table below can be used to correct the gas volume calculated where necessary:

Shielding gas	Factor
75% Ar/25% He	1.14
50% Ar/50% He	1.35
25% Ar/75% He	1.75
100% He	3.16





**Incorrect shielding gas setting!**

- ***If the shielding gas setting is too low or too high, this can introduce air to the weld pool and may cause pores to form.***
- ***Adjust the shielding gas quantity to suit the welding task!***

5.9.3 MIG/MAG welding with constant voltage characteristics (CV)

Default characteristics "CV constant voltage" for nearly all MIG/MAG processes

5.9.3.1 Selection

Operating element	Action	Result
<ul style="list-style-type: none"> ● TIG ● CV ● CC 		Select welding procedure Press the push-button until the CV (constant voltage) signal light illuminates.
		Set welding voltage

5.9.3.2 Advanced settings

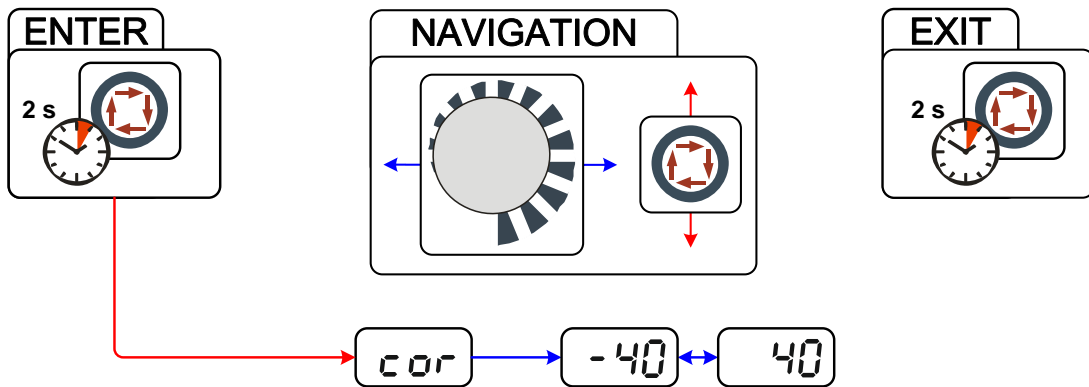







Figure 5-21

Display	Setting/selection
	Dynamic correction (setting -40 to 40, factory setting 0) <ul style="list-style-type: none"> • Increase value > harder arc • Decrease value > softer arc

5.9.4 MIG/MAG welding with constant current characteristics (CC)

Used for special wires (flux cored wires), which, according to the manufacturer, are to be welded using "CC constant current"

5.9.4.1 Selection

Operating element	Action	Result
<ul style="list-style-type: none"> ● TIG ● CV ● CC 		Select welding procedure Press the push-button until the CC (constant current) signal light illuminates.
		Set welding current

5.9.4.2 Advanced settings

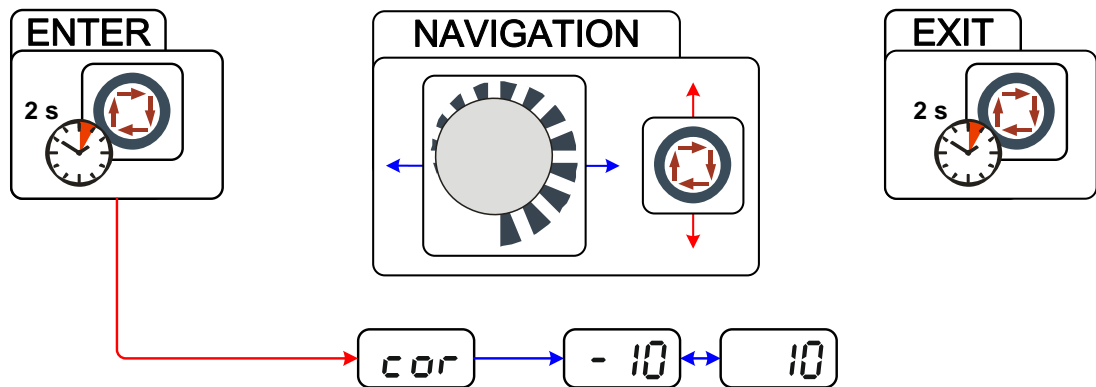



Figure 5-22

Display	Setting/selection
	Dynamic correction (setting -10 to 10, factory setting 0) <ul style="list-style-type: none"> • Increase value > harder arc • Decrease value > softer arc

5.10 MIG/MAG welding – voltage-sensing

5.10.1 General

This welding machine supports wire feeders with voltage detection (voltage-sensing). Voltage is supplied to these wire feeders solely by the welding voltage. The wire feeder has a lead to connect to the workpiece, to ensure voltage detection and supply. No other control cables are required. When activated, the power source provides a permanent supply and welding voltage for the wire feeder.

If a wire feeder without control cable or connection lead is connected to the power source and one of the MIG/MAG characteristics (CC/CV) is selected, the open circuit voltage is provided as supply voltage for the wire feeder at the welding current sockets.

5.10.2 Connection plan

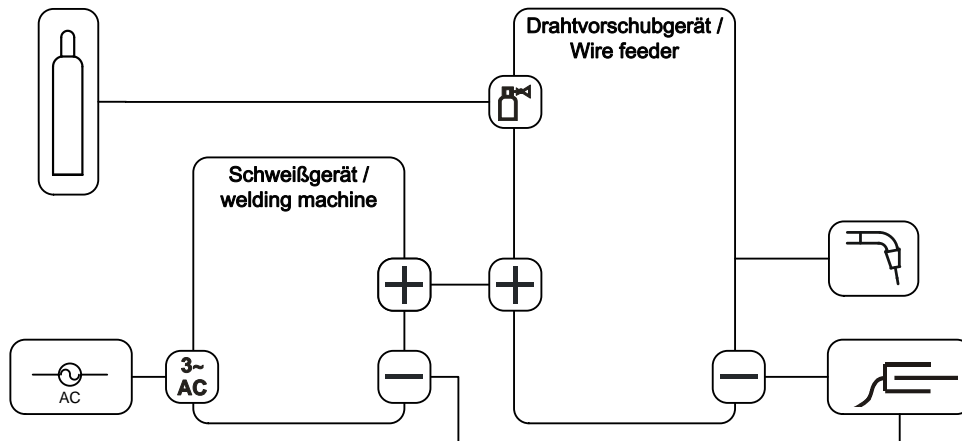

Figure 5-23

5.10.2.1 Legend

Symbol	Description
	Shielding gas
	Welding machine supply voltage
	Welding current (minus potential)
	Welding current (plus potential)
	Welding torch
	Workpiece

5.10.3 Connecting the supply lines

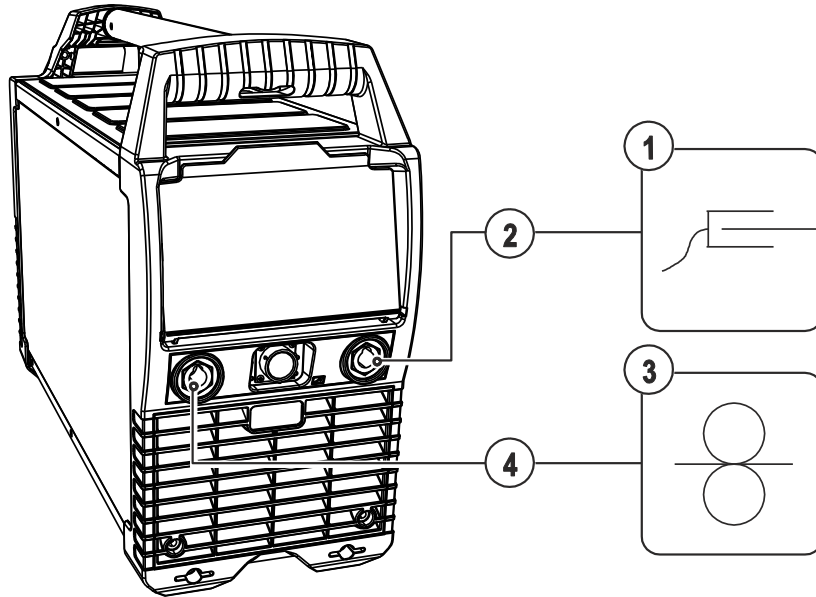

Figure 5-24

Item	Symbol	Description
1		Workpiece
2		"-" welding current connection socket • MIG/MAG welding: Workpiece connection
3		Wire feed unit
4		Connection socket, "+" welding current • MIG/MAG cored wire welding: Workpiece connection

- Insert the plug on the workpiece lead into the "-" welding current connection socket and lock.
- Attach and then lock the plug of the welding current lead (wire feeder) to the „+“ connection socket.



Some wire electrodes (e.g. self-shielding cored wire) are welded using negative polarity. In this case, the welding current lead should be connected to the "-" welding current socket, and the workpiece lead should be connected to the "+" welding current socket. Observe the information from the electrode manufacturer!

5.11 Remote control



Insert the remote control control cable into the 19-pole connection socket for remote control connection and lock.

5.11.1 Foot-operated remote control RTF1 19POL

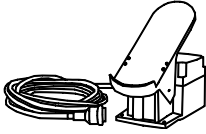

Features

- Infinitely adjustable welding current (0% to 100%) depending on the preselected main current on the welding machine.

5.11.2 Manual remote control RT1 19POL

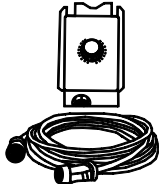

Functions

- Infinitely adjustable welding current (0% to 100%) depending on the preselected main current on the welding machine.

5.12 Voltage reducing device (VRD)

To increase safety, particularly in hazardous environments (like shipbuilding, pipe construction or mining), the machine is equipped with the VRD (Voltage-reducing device) voltage reduction device.

The VRD signal light is illuminated, when the voltage reduction device is operating without fault and the output voltage is reduced to a value specified in the relevant standard (see technical data). The voltage reduction device is only active on VRD machine versions.

The voltage reducing device is a requirement in some countries and in many internal company safety guidelines for power sources.

5.13 Dirt filter

- ☞ *These accessory components can be retrofitted as an option - See 9 Accessories chapter.*
- ☞ *The dirt filter can be used in places with unusually high levels of dirt and dust in the ambient air. The filter reduces the duty cycle of the welding machine via the reduced flow of cooling air. The filter must be disassembled and cleaned regularly depending on the level of dirt (blow out with compressed air).*

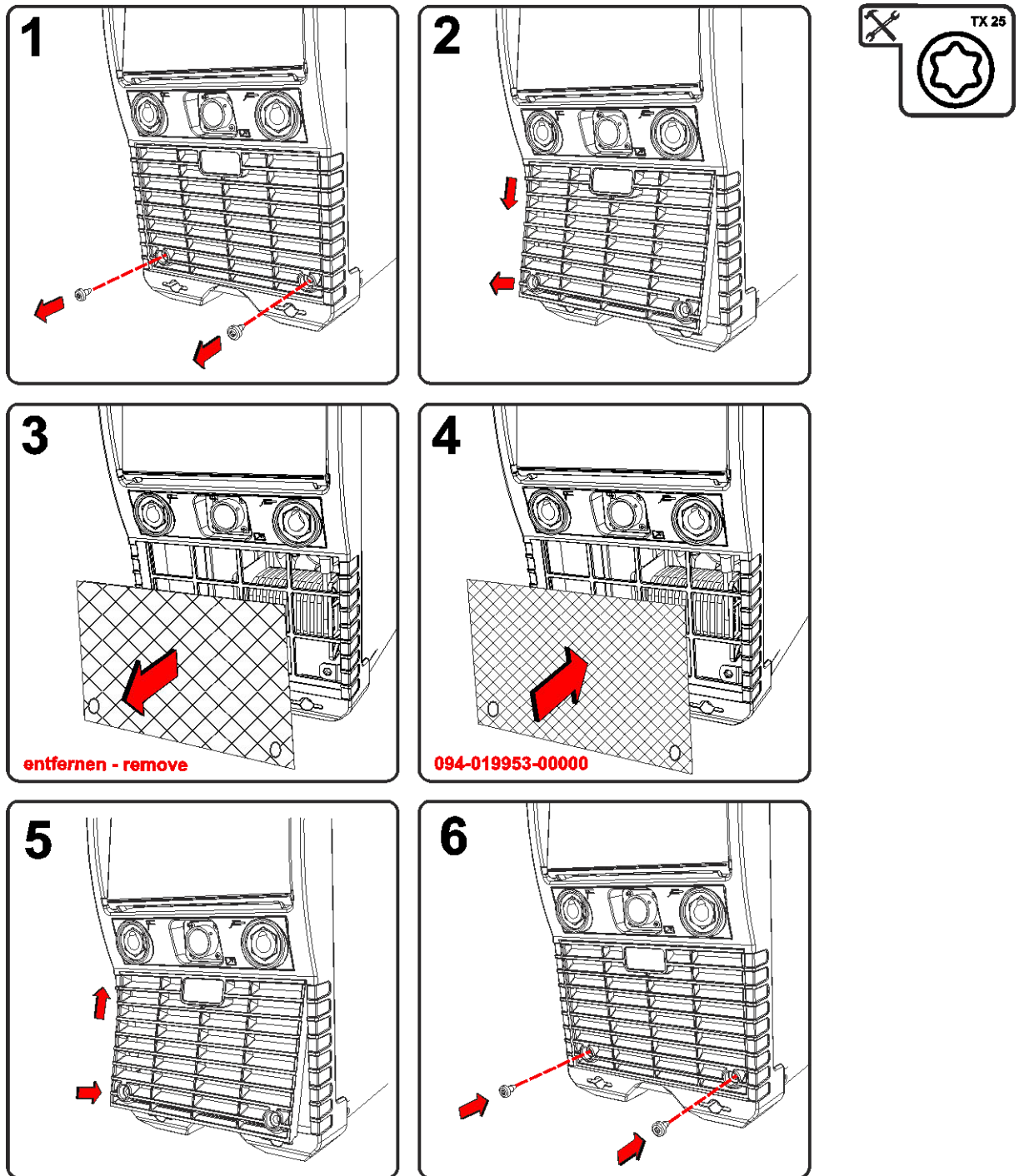

Figure 5-25

5.14 Machine configuration menu



ENTER (Enter the menu)

- Switch off machine at the main switch.
- Hold down the "Welding process" button and simultaneously switch the machine on again. Wait until the "Elt" menu item is shown and release the button.

NAVIGATION (navigating in the menu)

- Parameters are selected by pressing the "welding parameters" button.
- Set or change the parameters by turning the "welding parameter setting" rotary dial.

EXIT (Exit the menu)

- Select the "Elt" menu item.
- Press the "Welding parameters" button (settings will be applied, machine changes to the ready-to-operate status).

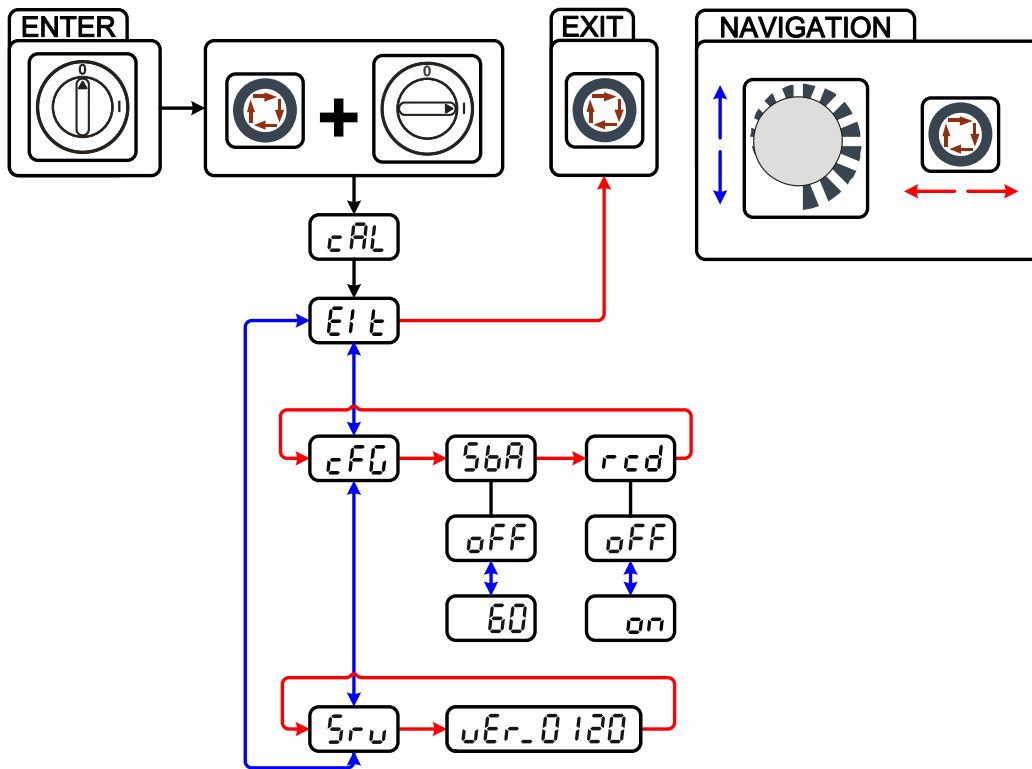



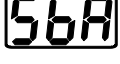

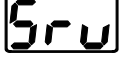



Figure 5-26

Display	Setting/selection
	Calibration The machine will be calibrated for approx 2 seconds each time it is switched on.
	Exit the menu Exit
	Machine configuration Settings for machine functions and parameter display
	Time-based power-saving mode <ul style="list-style-type: none"> • 5 min.–60 min. = Time to activation of power-saving mode in case of inactivity. • off = inactivated (ex works)
	Power display switching on Actual value display off Setpoint value display (factory setting)
	Service menu Modifications to the service menu may only be carried out by authorised maintenance staff!
	Software version of the machine control Version display

6 Maintenance, care and disposal

DANGER



Improper maintenance and testing

The equipment may only be cleaned, repaired or tested by specialist, skilled persons! A skilled person is one who, due to training, knowledge and experience, is able to recognise the dangers that can occur during testing of this equipment as well as possible subsequent damage and who is able to implement the required safety procedures.

- Complete all tests given in the chapter below!
- Only put the equipment back into operation following a successful test.



Risk of injury from electric shock!

Cleaning machines that are not disconnected from the mains can lead to serious injuries!

- Disconnect the machine completely from the mains.
- Remove the mains plug!
- Wait for 4 minutes until the capacitors have discharged!

Repair and maintenance work may only be performed by qualified authorised personnel; otherwise the right to claim under warranty is void. In all service matters, always consult the dealer who supplied the machine. Return deliveries of defective equipment subject to warranty may only be made through your dealer. When replacing parts, use only original spare parts. When ordering spare parts, please quote the machine type, serial number and item number of the machine, as well as the type designation and item number of the spare part.

6.1 General

When used in the specified environmental conditions and under normal operating conditions, this machine is largely maintenance-free and requires a minimum of care.

There are some points, which should be observed, to guarantee fault-free operation of your welding machine. Among these are regular cleaning and checking as described below, depending on the pollution level of the environment and the length of time the unit is in use.

6.2 Maintenance work, intervals

6.2.1 Daily maintenance tasks

6.2.1.1 Visual inspection

- Mains supply lead and its strain relief
- Gas tubes and their switching equipment (solenoid valve)
- Other, general condition

6.2.1.2 Functional test

- Welding current cables (check that they are fitted correctly and secured)
- Gas cylinder securing elements
- Operating, message, safety and adjustment devices (Functional test)

6.2.2 Monthly maintenance tasks

6.2.2.1 Visual inspection

- Casing damage (front, rear and side walls)
- Transport elements (strap, lifting lugs, handle)

6.2.2.2 Functional test

- Selector switches, command devices, emergency stop devices, voltage reducing devices, message and control lamps

6.2.3 Annual test (inspection and testing during operation)

 **The welding machine may only be tested by competent, capable persons!** A capable person is one who, because of his training, knowledge and experience, is able to recognise the dangers that can occur while testing welding power sources as well as possible subsequent damage and who is able to implement the required safety procedures.

 **For more information refer to the "Warranty registration" brochure supplied and our information regarding warranty, maintenance and testing at www.ewm-group.com!**

A periodic test according to IEC 60974-4 "Periodic inspection and test" has to be carried out. In addition to the regulations on testing given here, the relevant local laws and regulations must also be observed.

6.3 Disposing of equipment

 **Proper disposal!**

The machine contains valuable raw materials, which should be recycled, and electronic components, which must be disposed of.

- **Do not dispose of in household waste!**
- **Observe the local regulations regarding disposal!**



6.3.1 Manufacturer's declaration to the end user

- According to European provisions (guideline 2002/96/EG of the European Parliament and the Council of January, 27th 2003), used electric and electronic equipment may no longer be placed in unsorted municipal waste. It must be collected separately. The symbol depicting a waste container on wheels indicates that the equipment must be collected separately.
This machine is to be placed for disposal or recycling in the waste separation systems provided for this purpose.
- According to German law (law governing the distribution, taking back and environmentally correct disposal of electric and electronic equipment (ElektroG) from 16.03.2005), used machines are to be placed in a collection system separate from unsorted municipal waste. The public waste management utilities (communities) have created collection points at which used equipment from private households can be disposed of free of charge.
- Information about giving back used equipment or about collections can be obtained from the respective municipal administration office.
- EWM participates in an approved waste disposal and recycling system and is registered in the Used Electrical Equipment Register (EAR) under number WEEE DE 57686922.
- In addition to this, returns are also possible throughout Europe via EWM sales partners.

6.4 Meeting the requirements of RoHS

We, EWM AG Mündersbach, hereby confirm that all products supplied by us which are affected by the RoHS Directive, meet the requirements of the RoHS (Directive 2011/65/EU).

7 Rectifying faults

All products are subject to rigorous production checks and final checks. If, despite this, something fails to work at any time, please check the product using the following flowchart. If none of the fault rectification procedures described leads to the correct functioning of the product, please inform your authorised dealer.

7.1 Checklist for rectifying faults



The correct machine equipment for the material and process gas in use is a fundamental requirement for perfect operation!

Legend	Symbol	Description
	↘	Fault/Cause
	✘	Remedy

Excess temperature signal light illuminates

- ↘ Excess temperature, welding machine
- ✘ Allow the machine to cool down whilst still switched on

Functional errors

- ↘ Machine control without displaying the signal lights after switching on
 - ✘ Phase failure > check mains connection (fuses)
- ↘ Connection problems
 - ✘ Make control lead connections and check that they are fitted correctly.
- ↘ Loose welding current connections
 - ✘ Tighten power connections on the torch and/or on the workpiece
 - ✘ Tighten contact tip correctly

7.2 Error messages (power source)

 **A welding machine error is indicated by an error code being displayed (see table) on the display on the machine control.**

In the event of a machine error, the power unit is shut down.

 **The display of possible error numbers depends on the machine version (interfaces/functions).**

- If multiple errors occur, these are displayed in succession.
- Document machine errors and inform service staff as necessary.

Error message	Possible cause	Remedy
E 0	Start signal set in the event of errors	Do not press the torch trigger or the foot-operated remote control
E 4	Temperature error	Allow the machine to cool down
E 5	Mains overvoltage	Switch off the machine and check the mains voltage
E 6	Mains undervoltage	
E 7	Electronics error	Switch the machine on and off again.
E 9	Secondary overvoltage	If the error persists, notify service department
E12	Voltage reduction error (VRD)	
E13	Electronics error	
E14	Adjustment error in current recording	Switch off the machine, place the electrode holder in an insulated position and switch the machine back on. If the error persists, notify service department
E15	Error in one of the electronics supply voltages	Switch the machine off and on again. If the error persists, notify service department
E23	Temperature error	Allow the machine to cool down
E32	Electronics error	Switch the machine on and off again. If the error persists, notify service department
E33	Adjustment error in voltage recording	Switch off the machine, place the electrode holder in an insulated position and switch the machine back on. If the error persists, notify service department
E34	Electronics error	Switch the machine on and off again. If the error persists, notify service department
E37	Temperature error	Allow the machine to cool down
E40	Motor fault	Check wire feed unit, switch the machine off and on again, inform the service department if the fault persists.
E55	Failure of a mains phase	Switch off the machine and check the mains voltage
E58	Short circuit in welding circuit	Switch off machine and check welding current leads for correct installation, e.g., put down electrode holder in an electrically insulated manner, disconnect degausser current lead.

7.3 Resetting welding parameters to the factory settings

All customised welding parameters that are stored will be replaced by the factory settings.

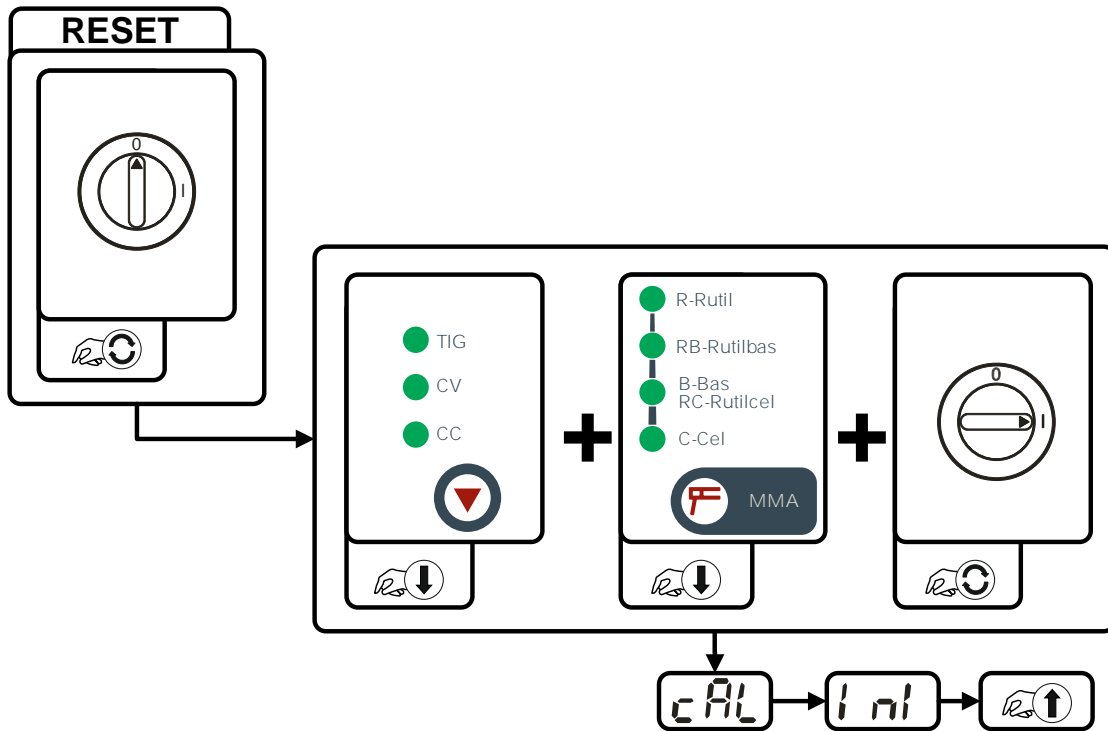



Figure 7-1

Display	Setting/selection
	Calibration The machine will be calibrated for approx 2 seconds each time it is switched on.
	Initialising Keep the push-button pressed until "InI" is shown on the display.



8 Technical data

 **Performance specifications and guarantee only in connection with original spare and replacement parts!**

8.1 Pico 350 cel puls

	MMA	TIG	MIG/MAG
Current setting range	10–350 A		
Voltage setting range	20.4 V–34.0 V	10.4 V–24.0 V	14.0 V–31.5 V
Duty cycle 25 °C			
45%	350 A		
60%	310 A		
100%	260 A		
Duty cycle 40 °C			
35%	350 A		
60%	280 A		
100%	230 A		
Load cycle	10 min. (60% DC \wedge 6 min. welding, 4 min. pause)		
Open circuit voltage	95 V		
Open circuit voltage:(VRD off)	33 V	12 V	33 V
Open circuit voltage:(VRD RU)	12 V	12 V	12 V
Mains voltage (tolerances)	3 x 400 V (+20% to -25 %)		
Frequency	50/60 Hz		
Mains fuse (safety fuse, slow-blow)	3 x 16 A		
Mains connection lead	H07RN-F4G2,5		
Max. connected load	15.0 kVA	10.6 kVA	13.9 kVA
Recommended generator rating	20.3 kVA		
cos ϕ /efficiency	0.99/88%		
Insulation class/protection classification	H/IP 34s		
Ambient temperature	-25 °C to +40 °C		
Machine cooling/torch cooling	Fan/gas		
Workpiece lead	50 mm ²		
Dimensions L/W/H	600 x 205 x 415 mm		
Weight	23.5 kg		
EMC class	A		
Constructed to standard	IEC 60974-1, -10 ГОСТ 12.2 007.8 (VRD RU) AS 1674.2-2003 (VRD AUS)  / 		

8.2 Pico 350 cel puls 460V

	MMA	TIG	MIG/MAG
Current setting range	10–350 A		
Voltage setting range	20.4 V–34.0 V	10.4 V–24.0 V	14.0 V–31.5 V
Duty cycle 25 °C			
40%	350 A		
60%	310 A		
100%	260 A		
Duty cycle 40 °C			
35%	350 A		
60%	280 A		
100%	230 A		
Load cycle	10 min. (60% DC \wedge 6 min. welding, 4 min. pause)		
Open circuit voltage	93 V		
Mains voltage (tolerances)	3 x 460 V (+25% to +20 %)		
Frequency	50/60 Hz		
Mains fuse (safety fuse, slow-blow)	3 x 16 A		
Mains connection lead	H07RN-F4G2,5		
Max. connected load	15.1 kVA	10.6 kVA	13.9 kVA
Recommended generator rating	20.4 kVA		
cos ϕ /efficiency	0.99/88%		
Insulation class/protection classification	H/IP 34s		
Ambient temperature	-25 °C to +40 °C		
Machine cooling/torch cooling	Fan/gas		
Workpiece lead	50 mm ²		
Dimensions L/W/H	600 x 205 x 415 mm		
Weight	23.5 kg		
EMC class	A		
Constructed to standard	IEC 60974-1, -10  / 		

9 Accessories

 *Performance-dependent accessories like torches, workpiece leads, electrode holders or intermediate hose packages are available from your authorised dealer.*

9.1 Remote controls and accessories

Type	Designation	Item no.
RT1 19POL	Remote control current	090-008097-00000
RA5 19POL 5M	Remote control e.g. connection cable	092-001470-00005
RA10 19POL 10M	Remote control e.g. connection cable	092-001470-00010
RA20 19POL 20M	Remote control e.g. connection cable	092-001470-00020
RTF1 19POL 5 M	Foot-operated remote control current with connection cable	094-006680-00000
RV5M19 19POLE 5M	Extension cable	092-000857-00000

9.2 Options

Type	Designation	Item no.
ON Filter Pico 350	Dirt filter for air inlet	092-002756-00000

9.3 General accessories

Type	Designation	Item no.
DMDIN TN 200B AR/MIX 35L	Manometer pressure regulator	094-000009-00000
5POLE/CEE/32A/M	Machine plug	094-000207-00000

9.4 System components

9.4.1 Wire feed unit

Type	Designation	Item no.
Pico drive 4L	Wire feeder	090-002121-00502
Pico drive 200C	Wire feeder	090-002124-00502

10 Appendix A

10.1 Overview of EWM branches

Headquarters

EWM AG
Dr. Günter-Henle-Straße 8
56271 Mündersbach · Germany
Tel: +49 2680 181-0 · Fax: -244
www.ewm-group.com · info@ewm-group.com

Technology centre

EWM AG
Forststraße 7-13
56271 Mündersbach · Germany
Tel: +49 2680 181-0 · Fax: -144
www.ewm-group.com · info@ewm-group.com



Production, Sales and Service

EWM AG
Dr. Günter-Henle-Straße 8
56271 Mündersbach · Germany
Tel: +49 2680 181-0 · Fax: -244
www.ewm-group.com · info@ewm-group.com

EWM HIGH TECHNOLOGY (Kunshan) Ltd.
10 Yuanshan Road, Kunshan · New & Hi-tech Industry Development Zone
Kunshan City · Jiangsu · Post code 215300 · People's Republic of China
Tel: +86 512 57867-188 · Fax: -182
www.ewm.cn · info@ewm.cn · info@ewm-group.cn

EWM HIGHTEC WELDING s.r.o.
9. května 718 / 31
407 53 Jířkov · Czech Republic
Tel: +420 412 358-551 · Fax: -504
www.ewm-jirikov.cz · info@ewm-jirikov.cz

Sales and Service Germany

EWM AG
Sales and Technology Centre
Grünauer Fenn 4
14712 Rathenow · Tel: +49 3385 49402-0 · Fax: -20
www.ewm-rathenow.de · info@ewm-rathenow.de

EWM AG
Rudolf-Winkel-Straße 7-9
37079 Göttingen · Tel: +49 551-3070713-0 · Fax: -20
www.ewm-goettingen.de · info@ewm-goettingen.de

EWM AG
Sachsstraße 28
50259 Pulheim · Tel: +49 2234 697-047 · Fax: -048
www.ewm-pulheim.de · info@ewm-pulheim.de

EWM AG
August-Horch-Straße 13a
56070 Koblenz · Tel: +49 261 963754-0 · Fax: -10
www.ewm-koblenz.de · info@ewm-koblenz.de

EWM AG
Eiserfelder Straße 300
57080 Siegen · Tel: +49 271 3878103-0 · Fax: -9
www.ewm-siegen.de · info@ewm-siegen.de

EWM HIGHTEC WELDING GmbH
Sales and Technology Centre
Draisstraße 2a
69469 Weinheim · Tel: +49 6201 84557-0 · Fax: -20
www.ewm-weinheim.de · info@ewm-weinheim.de

EWM Schweißtechnik Handels GmbH
Karlsdorfer Straße 43
88069 Tettang · Tel: +49 7542 97998-0 · Fax: -29
www.ewm-tettang.de · info@ewm-tettang.de

EWM Schweißtechnik Handels GmbH
Pffaffensteg 17
89143 Blaubeuren · Tel: +49 7344 9191-75 · Fax: -77
www.ewm-blaubeuren.de · info@ewm-blaubeuren.de

EWM Schweißtechnik Handels GmbH
Heinkelstraße 8
89231 Neu-Ulm · Tel: +49 731 7047939-0 · Fax: -15
www.ewm-neu-ulm.de · info@ewm-neu-ulm.de

Sales and Service International

EWM HIGH TECHNOLOGY (Kunshan) Ltd.
10 Yuanshan Road, Kunshan · New & Hi-tech Industry Development Zone
Kunshan City · Jiangsu · Post code 215300 · People's Republic of China
Tel: +86 512 57867-188 · Fax: -182
www.ewm.cn · info@ewm.cn · info@ewm-group.cn

EWM HIGHTEC WELDING GmbH
Wiesenstraße 27b
4812 Pinsdorf · Austria · Tel: +43 7612 778 02-0 · Fax: -20
www.ewm-austria.at · info@ewm-austria.at

Liaison office Turkey

EWM AG Türkiye İrtibat Bürosu
İkitelli OSB Mah. · Marmara Sanayi Sitesi P Blok Apt. No: 44
Küçükçekmece / İstanbul Türkiye
Tel: +90 212 494 32 19
www.ewm-istanbul.com.tr · info@ewm-istanbul.com.tr

EWM HIGHTEC WELDING UK Ltd.
Unit 2B Coopies Way · Coopies Lane Industrial Estate
Morpeth · Northumberland · NE61 6JN · Great Britain
Tel: +44 1670 505875 · Fax: -514305
www.ewm-morpeth.co.uk · info@ewm-morpeth.co.uk

EWM HIGHTEC WELDING Sales s.r.o. / Prodejní a poradenské centrum
Tyršova 2106
256 01 Benešov u Prahy · Czech Republic
Tel: +420 317 729-517 · Fax: -712
www.ewm-benesov.cz · info@ewm-benesov.cz

Plants

Branches

Liaison office

● More than 400 EWM sales partners worldwide